

# JVC



## DIGITAL VIDEO CAMERA

# GR-DVX4

Please visit our CyberCam Homepage on the World Wide Web and answer our Consumer Survey (in English only):

<http://www.jvc-victor.co.jp/english/index-e.html>

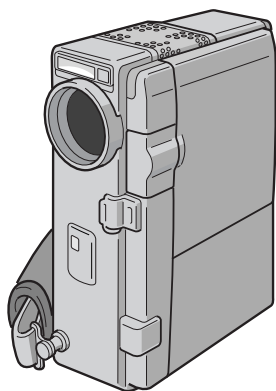

Mini **DV** PAL

## INSTRUCTIONS

### CONTENTS

<i>PROVIDED ACCESSORIES</i>	<b>4</b>
<i>ABOUT DV</i>	<b>5</b>
<i>GETTING STARTED</i>	<b>6 – 13</b>
<i>RECORDING</i>	<b>14 – 41</b>
Basic Recording .....	14
Advanced Features .....	20
<i>PLAYBACK</i>	<b>42 – 49</b>
Basic Playback .....	42
Advanced Features .....	44
Basic Connections .....	46
Advanced Connections .....	48
<i>TAPE DUBBING</i>	<b>50 – 51</b>
Tape Dubbing .....	50
Digital Dubbing .....	51
<i>USING THE REMOTE CONTROL UNIT</i>	<b>52 – 62</b>
Random Assemble Editing .....	56
For More Accurate Editing .....	60
Audio Dubbing .....	62
<i>TROUBLESHOOTING</i>	<b>63 – 68</b>
<i>USER MAINTENANCE</i>	<b>69</b>
<i>INDEX</i>	<b>70 – 75</b>
Controls, Connectors And Indicators .....	70
Indications .....	72
Docking Station .....	74
Terms .....	75
<i>CAUTIONS</i>	<b>76 – 77</b>
<i>SPECIFICATIONS</i>	<b>78 – 79</b>

**Dear Customer,**

Thank you for purchasing this digital video camera. Before use, please read the safety information and precautions contained in the following pages to ensure safe use of this product.

**Using This Instruction Manual**

- All major sections and subsections are listed in the Table Of Contents (☞ cover page).
- Notes appear after most subsections. Be sure to read these as well.
- Basic and advanced features/operation are separated for easier reference.

**It is recommended that you . . .**

- .... refer to the Index (☞ pgs. 70 – 75) and familiarize yourself with button locations, etc. before use.
- .... read thoroughly the Safety Precautions. They contain extremely important information regarding the safe use of this product.

You are recommended to carefully read the cautions on pages 76 and 77 before use.

# SAFETY PRECAUTIONS

**IMPORTANT****Connection to the mains supply in the United Kingdom.****DO NOT cut off the mains plug from this equipment.**

If the plug fitted is not suitable for the power points in your home or the cable is too short to reach a power point, then obtain an appropriate safety approved extension lead or consult your dealer.

**BE SURE to replace the fuse only with an identical approved type, as originally fitted, and to replace the fuse cover.**

If nonetheless the mains plug is cut off be sure to remove the fuse and dispose of the plug immediately, to avoid possible shock hazard by inadvertent connection to the mains supply.

If this product is not supplied fitted with a mains plug then follow the instructions given below:

**DO NOT** make any connection to the Larger Terminal coded E or Green.

The wires in the mains lead are coloured in accordance with the following code:



Blue to N (Neutral) or Black  
Brown to L (Live) or Red

If these colours do not correspond with the terminal identifications of your plug, connect as follows:

Blue wire to terminal coded N (Neutral) or coloured black.

Brown wire to terminal coded L (Live) or coloured Red.

If in doubt — consult a competent electrician.

**WARNING:  
TO PREVENT FIRE OR SHOCK  
HAZARD, DO NOT EXPOSE  
THIS UNIT TO RAIN OR  
MOISTURE.****Warning on lithium cell battery  
(for remote control unit)**

The battery used in this device may present a fire or chemical burn hazard if mistreated. Do not recharge, disassemble, heat above 100°C or incinerate.

Replace the battery with Maxell, Panasonic (Matsushita Electric), Sanyo or Sony CR2025; use of another battery may present a risk of fire or explosion.

- Dispose of used battery promptly.
- Keep away from children.
- Do not disassemble and do not dispose of in fire.

**CAUTIONS:**

- To prevent shock, do not open the cabinet. No user serviceable parts inside. Refer servicing to qualified personnel.
- When you are not using the AC Power Adapter/Charger for a long period of time, it is recommended that you disconnect the power cord from AC outlet.

**NOTES:**

- *The rating plate (serial number plate) and safety caution are on the bottom and/or the back of the main unit.*
- *The rating plate (serial number plate) of the AC Power Adapter/Charger is on its bottom.*

This camcorder is designed to be used with PAL-type colour television signals. It cannot be used for playback with a television of a different standard. However, live recording and LCD monitor/ viewfinder playback are possible anywhere. Use the BN-V507U/V514U battery packs and, to recharge them, the provided multi-voltage AC Power Adapter/Charger. (An appropriate conversion adapter may be necessary to accommodate different designs of AC outlets in different countries.)

This unit is produced to comply with Standard IEC Publ. 65.

## SOME DO'S AND DON'TS ON THE SAFE USE OF EQUIPMENT

**This equipment has been designed and manufactured to meet international safety standards but, like any electrical equipment, care must be taken if you are to obtain the best results and safety is to be assured.**

- DO** read the operating instructions before you attempt to use the equipment.
- DO** ensure that all electrical connections (including the mains plug, extension leads and interconnections between pieces of equipment) are properly made and in accordance with the manufacturer's instructions. Switch off and withdraw the mains plug when making or changing connections.
- DO** consult your dealer if you are ever in doubt about the installation, operation or safety of your equipment.
- DO** be careful with glass panels or doors on equipment.
- DON'T** continue to operate the equipment if you are in any doubt about it working normally, or if it is damaged in any way — switch off, withdraw the mains plug and consult your dealer.
- DON'T** remove any fixed cover as this may expose dangerous voltages.
- DON'T** leave equipment switched on when it is unattended unless it is specifically stated that it is designed for unattended operation or has a standby mode. Switch off using the switch on the equipment and make sure that your family knows how to do this. Special arrangements may need to be made for infirm or handicapped people.
- DON'T** use equipment such as personal stereos or radios so that you are distracted from the requirements of road safety. It is illegal to watch television whilst driving.
- DON'T** listen to headphones at high volume, as such use can permanently damage your hearing.
- DON'T** obstruct the ventilation of the equipment, for example with curtains or soft furnishings. Overheating will cause damage and shorten the life of the equipment.
- DON'T** use makeshift stands and NEVER fix legs with wood screws — to ensure complete safety always fit the manufacturer's approved stand or legs with the fixings provided according to the instructions.
- DON'T** allow electrical equipment to be exposed to rain or moisture.
- ABOVE ALL**
  - NEVER let anyone especially children push anything into holes, slots or any other opening in the case — this could result in a fatal electrical shock;
  - NEVER guess or take chances with electrical equipment of any kind — it is better to be safe than sorry!

# SAFETY PRECAUTIONS

Do not point the lens or the viewfinder directly into the sun. This can cause eye injuries, as well as lead to the malfunctioning of internal circuitry. There is also a risk of fire or electric shock.

**CAUTION!** The following notes concern possible physical damage to the camcorder and to the user.

When carrying, be sure to always attach and use the provided hand strap. Hold the camcorder firmly in your hand, with the strap securely around your wrist. Carrying or holding the camcorder by the viewfinder and/or the LCD monitor can result in dropping the unit, or in a malfunction.

Take care not to get your finger caught in the cassette cover. Do not let children operate the camcorder, as they are particularly susceptible to this type of injury.

Do not use a tripod on unsteady or unlevel surfaces. It could tip over, causing serious damage to the camcorder.

**CAUTION!** Attaching the camcorder to the Docking Station with cables (Audio/Video, S-Video, Editing, DC, etc.) connected, then leaving it on top of the TV is not recommended, as tripping on the cables will cause the camcorder to fall, resulting in damage.

## Mini DV PAL

- This camcorder is designed exclusively for the digital video cassette. Only cassettes marked **Mini DV** can be used with this unit.

*Before recording an important scene . . .*

- .... make sure you only use cassettes with the Mini DV mark **Mini DV**.
- .... remember that this camcorder is not compatible with other digital video formats.
- .... remember that this camcorder is intended for private consumer use only. Any commercial use without proper permission is prohibited. (Even if you record an event such as a show, performance or exhibition for personal enjoyment, it is strongly recommended that you obtain permission beforehand.)

## PROVIDED ACCESSORIES

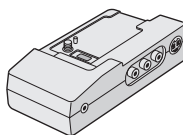

• Docking Station  
CU-V501E

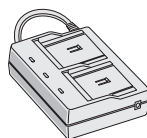

• AC Power  
Adapter/Charger  
AA-V50EK

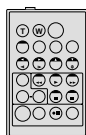

• Remote Control Unit  
RM-V713U

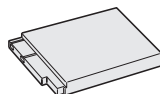

• Battery Pack  
BN-V507U



• Audio/Video (A/V)  
Cable [mini-plug  
to RCA plug]



• Audio/Video (A/V)  
Cable [RCA plug  
to RCA plug]



• Editing Cable



• S-Video Cable

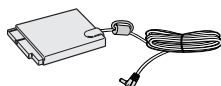

• DC Cord



• Core Filter x 3 (for  
optional DV cable,  
headphones and  
microphone)

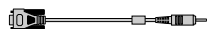

• PC Connection Cable



• JLIP Cable



• Cable Adapter



• CD-ROM  
The CD ROM contains  
the following 5  
software programmes:  
• JLIP Video Capture  
• JLIP Video Producer  
Presto!  
• Mr. Photo  
• PhotoAlbum  
• ImageFolio



• Lithium Battery  
CR2025  
(for remote  
control unit)



• Cleaning Cloth

The digital camcorder converts incoming audio and video signals into digital form for recording.

A video signal is composed of a luminance signal (Y) and colour signals (R-Y and B-Y). These signals are identified and recorded digitally (Digital Component Recording). The A/D (Analogue to Digital) converter samples the Y signal at 13.5 MHz, and R-Y and B-Y at 6.75 MHz, and changes them to an 8-bit quantum signal.

Sound sampled at 48 kHz is changed to a 16-bit quantum signal, and sound sampled at 32 kHz is converted to a 12-bit signal.

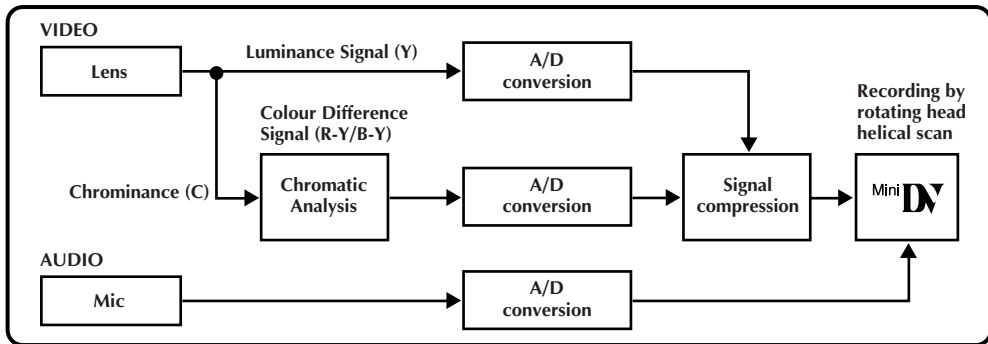

This camcorder separates the data into blocks, writing one block of each data type on each track of the tape.

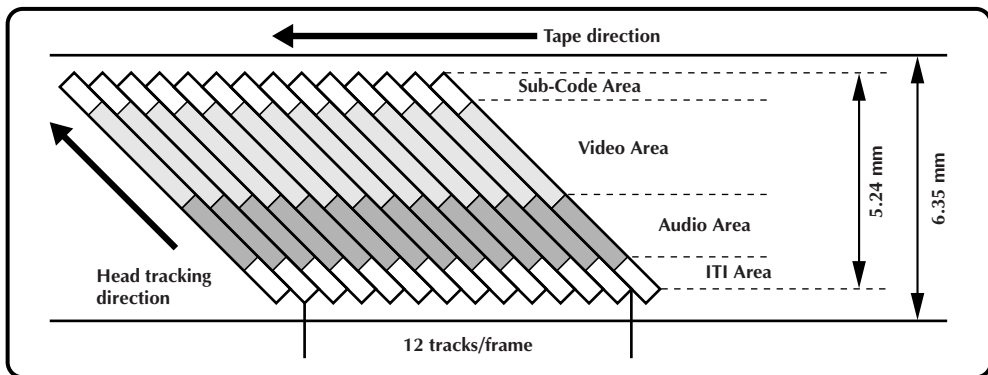

### 1 Sub-Code Area

The Time Code and Date/Time data are written here, separate from the video data. This enables you to display the date and time during playback, even if they weren't displayed while recording.

### 2 Video Area

The digital video signal is recorded here.

### 3 Audio Area

The digital audio signal is recorded here.

### 4 ITI (Insert and Tracking Information) Area

Insert editing and post-recording editing tracking signals are recorded here.

## Power

This camcorder's 2-way power supply system lets you choose the most appropriate source of power.

### NOTES:

- No function is available without power supply.
- Use only specified power supply.
- Do not use provided power supply units with other equipment.

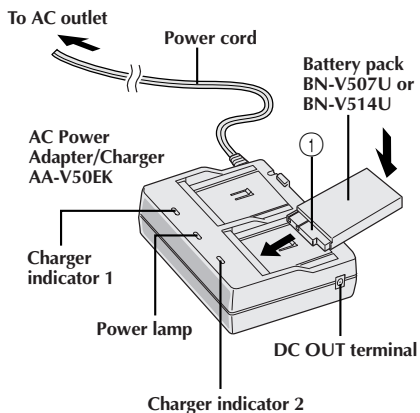

### NOTES:

- Perform charging where the temperature is between 10° and 30°C. 20° to 25°C is the ideal temperature range for charging. If the environment is too cold, charging may be incomplete.
- Charging times noted above are for fully discharged battery pack.
- Charging time varies according to the ambient temperature and the status of the battery pack.
- To avoid interference with reception, do not use the AC Power Adapter/Charger near a radio.
- If you connect the camcorder's DC cord to the adapter during battery charging, power is supplied to the camcorder and charging stops.
- Since the AC Power Adapter/Charger processes electricity internally, it becomes warm during use. Be sure to use it only in well-ventilated areas.
- When charging the battery pack for the first time or after a long storage period, the charger indicator may not light. In this case, remove the battery pack from the AC Power Adapter/Charger, then try charging again.
- If the battery operation time remains extremely short even after having been fully charged, the battery is worn out and needs to be replaced. Please purchase a new one.

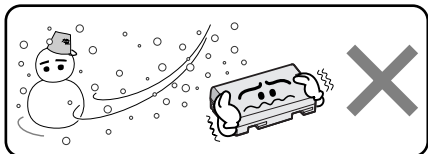

Lithium-ion is vulnerable in colder temperatures.

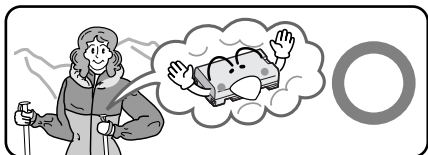

## CHARGING THE BATTERY PACK

### 1 SUPPLY POWER TO CHARGER

Make sure you unplug the camcorder's DC cord from the AC Power Adapter/Charger.

Plug the AC Adapter/Charger's power cord into an AC outlet. The power lamp comes on.

### 2 ATTACH BATTERY/BATTERIES

Attach the battery pack while making sure its terminal side ① is in contact with the indicator side of the battery pack mount on the AC Power Adapter/Charger.

- The Charger Indicator (1 or 2) begins blinking to indicate charging has started.

### 3 CONFIRM STATUS

When the charger indicator stops blinking but stays lit, charging is finished.

- If two batteries are attached to the charger, they will be charged in the order that they were attached.

### 4 DETACH BATTERY/BATTERIES

Slide the battery or batteries in the opposite direction of the arrow and lift off. Remember to unplug the AC Adapter/Charger's power cord from an AC outlet.

### Charging time

Battery pack	ONE	TWO
BN-V507U	approx. 1 hr. 30 min.	approx. 3 hrs.
BN-V514U (optional)	approx. 3 hrs.	approx. 6 hrs.

### About Batteries

**DANGER!** Do not attempt to take the batteries apart, or expose them to flame or excessive heat, as it may cause a fire or explosion.

**WARNING!** Do not allow the battery or its terminals to come in contact with metals, as this can result in a short circuit and possibly start a fire.

### The Benefits Of Lithium-Ion Batteries

Lithium-ion battery packs are small but have a large power capacity. However, when one is exposed to cold temperatures (below 10° C), its usage time becomes shorter and it may cease to function. If this happens, place the battery pack in your pocket or other warm, protected place for a short time, then re-attach it to the camcorder. As long as the battery pack itself is not cold, it should not affect performance.

(If you're using a heating pad, make sure the battery pack does not come in direct contact with it.)

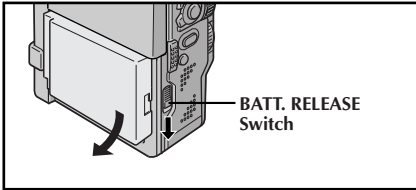
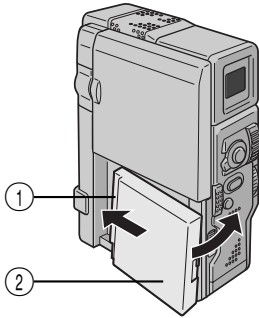

### ATTENTION:

Before detaching the power source, make sure that the camcorder's power is turned off. Failure to do so can result in a camcorder malfunction.

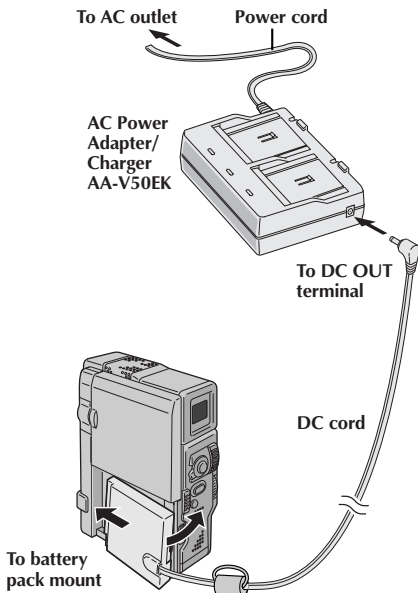

## USING THE BATTERY PACK

### 1 ATTACH BATTERY PACK

Insert the terminal end ① of the battery pack into the battery pack mount, then firmly push the end ② of the battery pack in the direction of the arrow until it locks into place as shown in the illustration.

- If the battery pack is attached in the wrong position, a malfunction may occur.

### To Detach The Battery Pack . . .

.... while sliding down **BATT. RELEASE**, detach it.

### NOTES:

- Continuous shooting is possible when the temperature is approx. 20°C.
  - However, continuous shooting capability is reduced significantly under the following conditions:
    - The temperature is below 10°C.
    - Zoom or Record-Standby mode is engaged repeatedly.
    - The LCD monitor is used repeatedly.
- Before extended use, it is recommended that you prepare enough battery packs to cover 3 times the planned shooting time.

### Approximate recording time

Battery pack	LCD monitor on/ Viewfinder off	LCD monitor off/ Viewfinder on
BN-V507U	55 min.	65 min.
BN-V514U	115 min.	130 min.
BN-V856U	7 hrs. 30 min.	8 hrs. 30 min.

### INFORMATION:

VU-V856KIT is a set composed of the BN-V856U battery pack and AA-V80EK AC Power Adapter/Charger. Also read thoroughly the VU-V856KIT's instruction manuals.

It is impossible to charge the BN-V856U battery pack using the provided AC Power Adapter/Charger. Use the optional AA-V80EK AC Power Adapter/Charger.

### USING AC POWER

Use the AC Power Adapter/Charger (connect as shown in the illustration).

### NOTES:

- The provided AC Power Adapter/Charger features automatic voltage selection in the AC range from 110 V to 240 V.
- For other notes, see pg. 6.

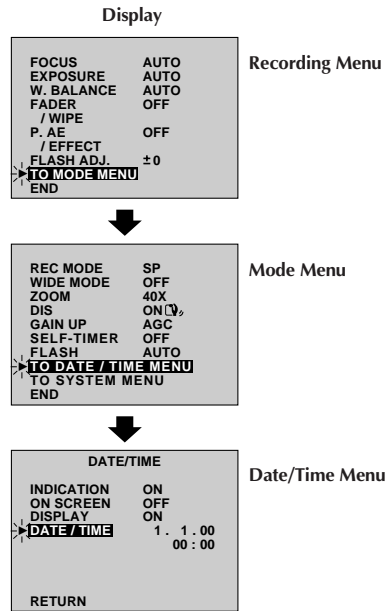
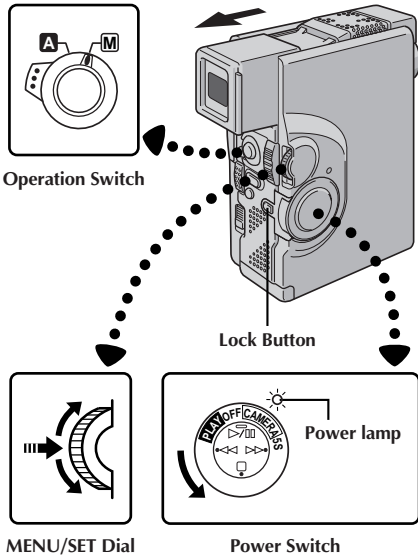

## Date/Time Settings

Date and time will automatically be recorded on tape at all times. It is your choice to display it or not during playback (☞ pg. 45).

- 1 SELECT OPERATION MODE**  
Set the Operation Switch to "M". Then, set the Power Switch to "CAMERA" or "5S" while pressing down the Lock Button. Open the LCD monitor fully or pull out the viewfinder fully.
  - The power lamp comes on and the camcorder is turned on.
- 2 ACCESS RECORDING MENU**  
Press MENU/SET. The Recording Menu appears.
- 3 ACCESS MODE MENU**  
Move the highlight bar to "TO MODE MENU" by rotating MENU/SET. Press it and the Mode Menu appears.
- 4 ACCESS DATE/TIME MENU**  
Move the highlight bar to "TO DATE/TIME MENU" by rotating MENU/SET. Press it and the Date/Time Menu appears.
- 5 INPUT DATE AND TIME**  
Move the highlight bar to "DATE/TIME" by rotating MENU/SET. Press it and "day" is highlighted and begins blinking. Rotating MENU/SET, input the day. Press it. Repeat the procedure to input the month, year, hour and minute.
  - Press MENU/SET twice when the highlight bar is set to "RETURN" to exit.

## Regarding Built-in Clock's Rechargeable Lithium Battery

To store the date/time in memory, the clock's rechargeable lithium battery is integrated in the camcorder. While the camcorder is connected to an AC outlet using the AC Power Adapter/Charger, or while the battery pack attached to the camcorder continues to supply power to the camcorder, the clock's rechargeable lithium battery is always charged. However, if the camcorder is not used for approx. 3 months, the clock lithium battery will become discharged and the date/time stored in memory will be lost. When this occurs, first connect the camcorder to an AC outlet using the AC Power Adapter/Charger for over 24 hours to charge the clock's rechargeable lithium battery. Then perform the date/time setting before using the camcorder. It is also possible to use the camcorder without the date/time setting.

## NOTE:

Even if you select "DATE/TIME", if the parameter is not highlighted the camcorder's internal clock continues to operate. Once you move the highlight bar to the first date/time parameter (day), the clock stops. When you finish setting the minute and press MENU/SET, the date and time begin operation from the date and time you just set.



## Loading/Unloading A Cassette

The camcorder needs to be powered up to load or eject a cassette.

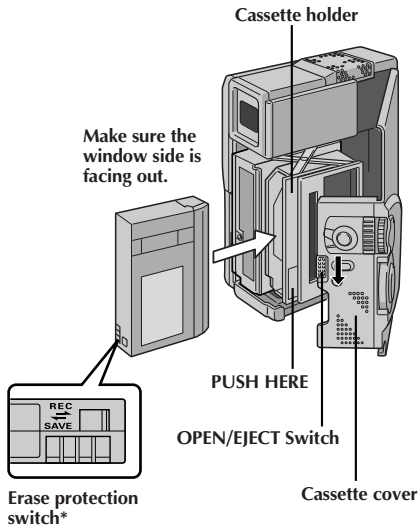

### 1 OPEN CASSETTE COVER

Slide **OPEN/EJECT** in the direction of the arrow then swing the cover open until it locks. The holder opens automatically.

- Do not touch internal components.

### 2 INSERT/REMOVE TAPE

Insert or remove a tape and press "PUSH HERE" to close the cassette holder.

- Once the cassette holder is closed, it recedes automatically. Wait until it recedes completely before closing the cassette cover.
- When the battery's charge is low, you may not be able to close the cover. Do not apply force. Replace the battery with a fully charged one before continuing.

### 3 CLOSE CASSETTE COVER

Close the cassette cover firmly until it locks into place.

#### \* To Protect Valuable Recordings . . .

.... slide the erase protection switch on the back of the tape in the direction of "SAVE". This prevents this tape from being recorded over. If you decide later that you do want to record on this tape, slide the switch back to "REC" before loading the tape.

#### Approximate recording time

Tape	Recording mode	
	SP	LP
DVM-30	30 min.	45 min.
DVM-60	60 min.	90 min.

## NOTES:

- It takes a few seconds for the cassette holder to open. Do not apply force.
- If you wait a few seconds and the cassette holder does not open, close the cassette cover and try again. If the cassette holder still does not open, turn the camcorder off then on again.
- If the tape does not load properly, open the cassette cover fully and remove the cassette. A few minutes later, insert it again.
- When the camcorder is suddenly moved from a cold place to a warm environment, wait a short time before opening the cover.
- Closing the cassette cover before the cassette holder comes out may cause damage to the camcorder.
- Even when the camcorder is switched off, a cassette can be loaded or unloaded. After the cassette holder is closed with the camcorder switched off, however, it may not recede. It is recommended to turn the power on before loading or unloading.
- When resuming recording, once you open the cassette cover a blank portion will be recorded on the tape or a previously recorded scene will be erased (recorded over) regardless of whether the cassette holder came out or not. See page 19 for information about recording from the middle of a tape.

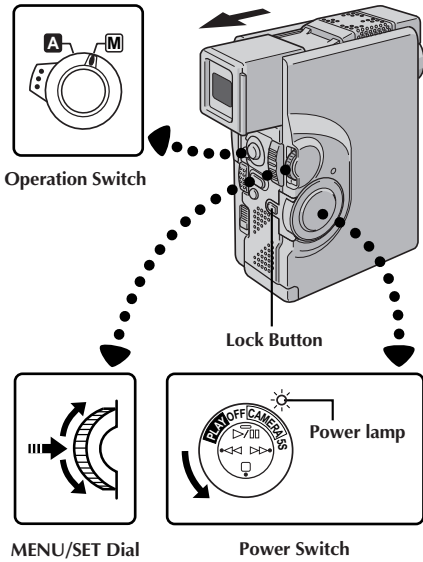

## Recording Mode Setting

Set depending on your preference.

**1 SELECT OPERATION MODE**  
 Set the Operation Switch to "M". Then, set the Power Switch to "CAMERA" or "5S" while pressing down the Lock Button. Open the LCD monitor fully or pull out the viewfinder fully.

- The power lamp comes on and the camcorder is turned on.

**2 ACCESS RECORDING MENU**  
 Press MENU/SET. The Recording Menu appears.

**3 ACCESS MODE MENU**  
 Move the highlight bar to "TO MODE MENU" by rotating MENU/SET. Press it and the Mode Menu appears.

**4 SET RECORDING MODE**  
 First move the highlight bar to "REC MODE" by rotating MENU/SET. Press it and the parameter "SP" or "LP" is highlighted. Select "SP" or "LP" by rotating MENU/SET. Press it twice to exit from the Recording Menu.

- Audio Dubbing is impossible on a tape recorded in the LP mode.
- "LP" (Long Play) is more economical, providing 1.5 times the recording time.

Display

FOCUS	AUTO
EXPOSURE	AUTO
W. BALANCE	AUTO
FADER / WIPE	OFF
P. AE	OFF
/ EFFECT	
FLASH ADJ.	±0
▶ TO MODE MENU	
END	

Recording Menu

▶ REC MODE	SP
WIDE MODE	OFF
ZOOM	40X
DIS	ONLY
GAIN UP	AGC
SELF-TIMER	OFF
FLASH	AUTO
TO DATE / TIME MENU	
TO SYSTEM MENU	
END	

Mode Menu

▶ REC MODE	SP
WIDE MODE	OFF
ZOOM	40X
DIS	ONLY
GAIN UP	AGC
SELF-TIMER	OFF
FLASH	AUTO
TO DATE / TIME MENU	
TO SYSTEM MENU	
END	

Recording mode indicator

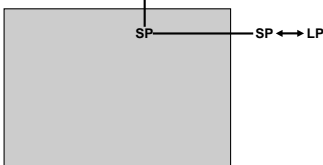

## NOTES:

- If the recording mode is switched during recording, the playback picture will be blurred at the switching point.
- It is recommended that tapes recorded in the LP mode on this camcorder be played back on this camcorder.
- During playback of a tape recorded on another camcorder, blocks of noise may appear or there may be momentary pauses in the sound.

START/STOP Button

Power Zoom Lever

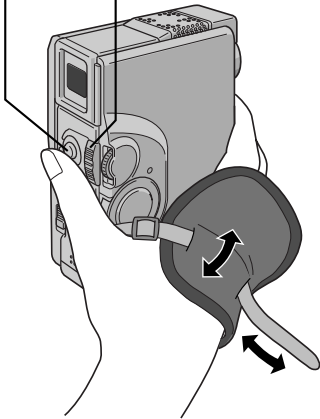

## Grip Adjustment

- 1 EXPAND LOOP**  
Separate the Velcro strip.
- 2 INSERT HAND**  
Pass your right hand through the loop and grasp the grip.
- 3 ADJUST STRAP LENGTH**  
Adjust so that your thumb and fingers can easily operate **START/STOP** and Power Zoom Lever.  
Refasten the Velcro strip.

### NOTE:

When carrying the camcorder inside a bag, etc., the grip belt's metal buckle may damage the camcorder. It is recommended that you place it inside the Velcro strip.

2

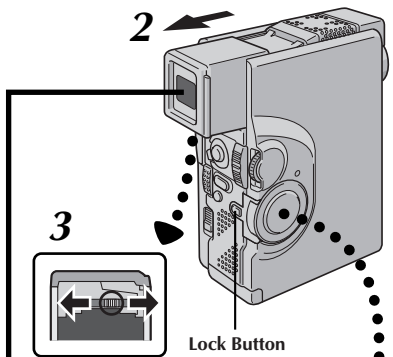

3

Lock Button

1

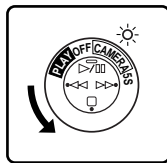

Set to "CAMERA"  
or "5S".

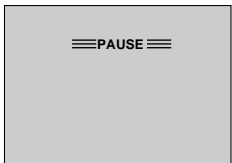

## Viewfinder Adjustment

- 1 SELECT OPERATION MODE**  
Set the Power Switch to "CAMERA" or "5S" while pressing down the Lock Button .
- 2 POSITION VIEWFINDER**  
Pull out the viewfinder fully.
  - The power lamp comes on and the camcorder is turned on.
- 3 ADJUST DIOPTR**  
Slide the Dioptre Adjustment Control until the indications in the viewfinder are clearly focused.

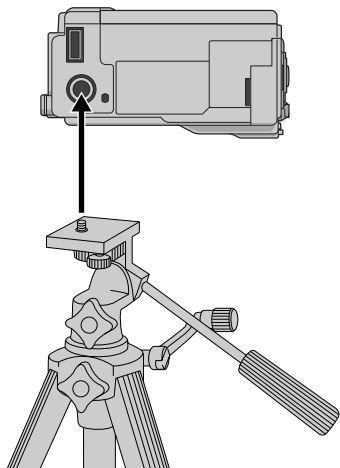

## Tripod Mounting

**1**

### ALIGN AND TIGHTEN

Align the screw on the tripod with the camera's mounting socket. Then tighten the screw.

### CAUTION:

When using a tripod, be sure to open and extend its legs fully to stabilise the camcorder. To prevent damage to the unit caused by falling over, do not use a small-sized tripod.

To turn on the camcorder, first set the Power Switch to any operation mode except "OFF", then pull out the viewfinder fully or open the LCD monitor. When setting the Power Switch, press and hold the Lock Button.

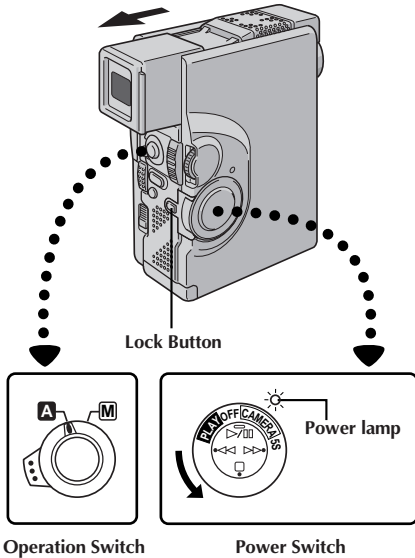

According to the Operation Switch position you have selected, "F.AUTO" or "MANUAL" appears in the upper left corner.

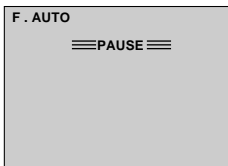

When set to "A"

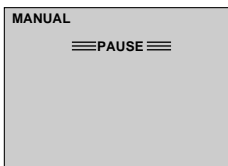

When set to "M"  
(When the Power Switch is set to "5S",  
"MANUAL" blinks.)

If the Power Switch is set to "PLAY", these indications do not appear.

## Operation Mode

Turning the Power Switch and Operation Switch allows you to choose the appropriate operation mode among the following table:

Power Switch/ Operation Switch Position		Function
Power Switch Position	<b>CAMERA</b>	Suitable for standard recording.
	<b>5 second recording mode: 5S</b>	Allows you to record in 5-second clips to keep the action moving. Enables shooting in Manual mode. However, Focus and Exposure are the same as in the Full Auto mode, and it is not possible to change menu settings using the MENU/SET Dial.
	<b>Playback: PLAY</b>	Allows you to play back a recording.  pg. 42 – 49.
	<b>OFF</b>	Allows you to switch off the camcorder. After setting to this position, Manual Focus and Exposure Control are automatically reset to "AUTO".
Operation Switch Position	<b>Full Auto: A</b>	Allows you to record using NO special effects or manual adjustments. Suitable for standard recording.
	<b>Manual: M</b>	Allows you to set various recording functions using the Menus. If you want more creative capabilities than Full Auto recording, try this mode.

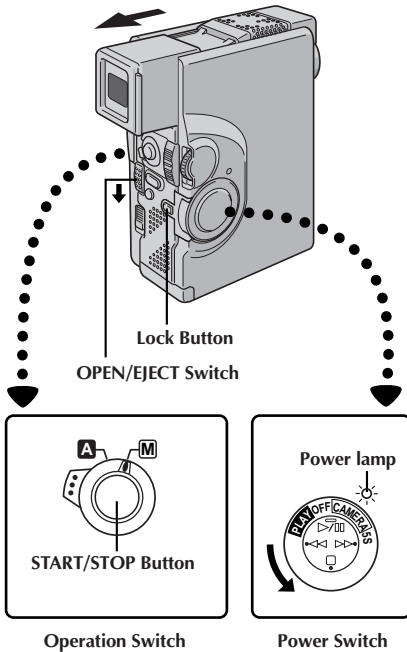

Tally lamp  
(lights while  
recording is  
in progress)

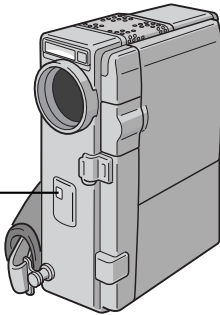
**NOTE:**

You should already have performed the procedures listed below. If not, do so before continuing.

- Power (☞ pg. 6)
- Recording Mode Setting (☞ pg. 10)
- Grip Adjustment (☞ pg. 11)
- Viewfinder Adjustment (☞ pg. 11)

**1 LOAD A CASSETTE**

Slide **OPEN/EJECT** in the direction of the arrow then swing the cover open until it locks. The holder opens automatically.

Insert a tape and press "PUSH HERE" to close the cassette holder.

- Once the cassette holder is closed, it recedes automatically. Wait until it recedes completely before closing the cassette cover.

**Shooting While Watching The Viewfinder****2 ENTER RECORD-STANDBY MODE**

Make sure the LCD monitor is closed and locked. Set the Operation Switch to "A" or "M". Then, set the Power Switch to "CAMERA" while pressing down the Lock Button. Pull out the viewfinder fully.

- The lens cover opens, the power lamp lights and the camcorder enters the Record-Standby mode.
- The scene you are aimed at appears on the viewfinder screen, with the word "PAUSE" superimposed upon it.

**3 START SHOOTING**

Press **START/STOP**.

- "REC" appears in the viewfinder while recording is in progress.

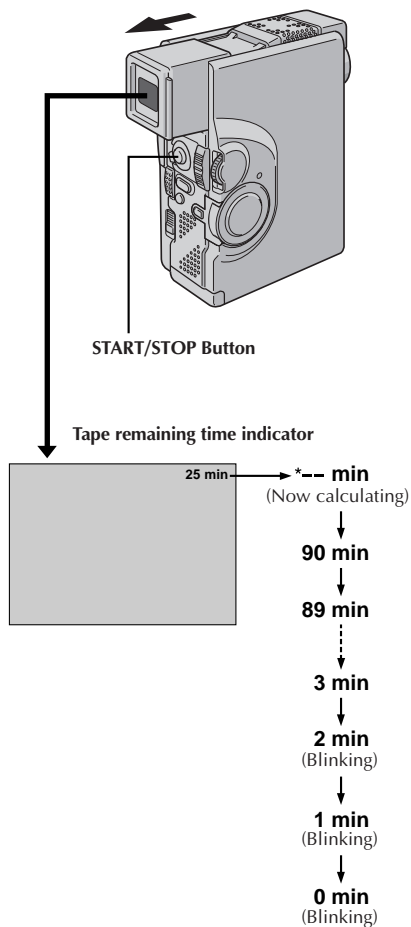

## 4 STOP RECORDING

Press **START/STOP** again to stop recording.

- The camcorder re-enters the Record-Standby mode.

### NOTES:

- The image will not appear simultaneously in the LCD monitor and the viewfinder. No image appears on the LCD monitor when the viewfinder is pulled out. It is not possible to shoot using both LCD monitor and viewfinder. However, during Interface Shooting (☞ pg. 17) the image appears simultaneously in the LCD monitor and the viewfinder.
- The cassette holder cannot be opened unless a power supply is attached.
- There may be a delay after you open the cassette cover until the holder opens. Do not use force.
- The indicated tape remaining time is approximate.
- The time required to calculate and to display the remaining tape length, and the accuracy of the calculation, may vary according to the type of tape used.
- "TAPE END" appears when the tape reaches its end, and the power goes off automatically if left in this condition for 5 minutes. "TAPE END" also appears when a cassette whose tape is already at its end is loaded.
- If the Record-Standby mode continues for 5 minutes, the camcorder's power shuts off automatically. To turn the camcorder on again, push back and pull out the viewfinder again or close and re-open the LCD monitor.
- When a blank portion is left between recorded scenes on the tape, the time code is interrupted and errors may occur when editing the tape. Continue recording from where you stop so that there are no gaps by following "Recording from the middle of a tape" (☞ pg. 19).
- During recording, sound is not heard from the speaker. If you want to hear the sound, connect optional headphones to the headphones connector. The sound volume at this point is the same as the level it was adjusted during playback.
- To turn the tally lamp off during recording, refer to pgs. 28 and 30.

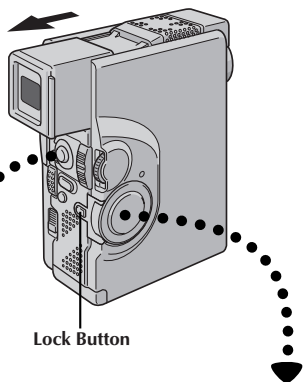
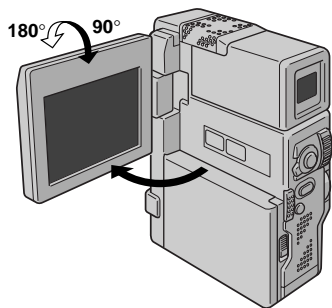

Lock Button

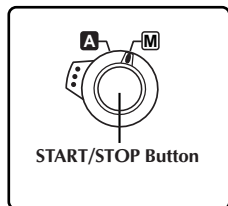

START/STOP Button

Operation Switch

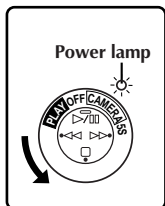

Power lamp

Power Switch

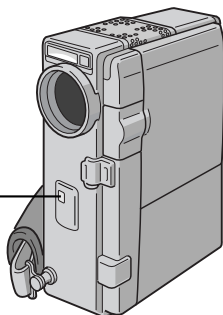
Tally lamp  
(lights while  
recording is  
in progress)

## Shooting While Watching The LCD Monitor

Before the following steps, perform step 1 (pg. 14).

### 2 ENTER RECORD-STANDBY MODE

Make sure the viewfinder is pushed back in. Set the Operation Switch to "A" or "M". Then, set the Power Switch to "CAMERA" while pressing down the Lock Button. Open the LCD monitor fully.

- The lens cover opens, the power lamp lights and the camcorder enters the Record-Standby mode.
- The scene you are aimed at appears in the LCD monitor, with the word "PAUSE" superimposed on it.

### 3 START SHOOTING

Tilt the LCD monitor upward/downward for best viewability (pg. 17) and press START/STOP.

- "REC" appears in the LCD monitor while recording is in progress.

### 4 STOP RECORDING

Press START/STOP again to stop recording.

- The camcorder re-enters the Record-Standby mode.

### NOTES:

- When you use the LCD monitor outdoors in direct sunlight, the LCD monitor may be difficult to see. If this happens, we recommend that you use the viewfinder (pg. 14).
- To turn the tally lamp off during recording, refer to pgs. 28 and 30.
- For other notes, refer to pg. 15.



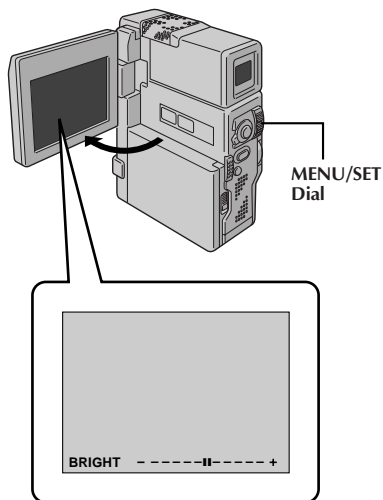

## Journalistic Shooting

In some situations different angles of shooting may be required for more dramatic results.

### 1 OPEN LCD MONITOR

Make sure the LCD monitor is fully open.

### 2 TILT LCD MONITOR

Tilt the LCD monitor in the most convenient direction.

- The LCD monitor can rotate almost full circle (270°: 90° downward, 180° upward).

## Interface Shooting

A person you shoot can view himself/herself in the LCD monitor, and you can even shoot yourself while viewing your own image in the LCD monitor.

### 1 TILT LCD MONITOR UPWARD

Open the LCD monitor and tilt it upward to 180 degrees so that it faces forward.

- The monitor image is inverted vertically. If the viewfinder is pulled out at that time, it will also switch on.

### 2 START RECORDING

Point the lens toward the subject (yourself when self-recording) and start recording.

- During Interface Shooting, the "Tape Running" indicator and warning indications (see pg. 72, 73) are the only ones that are shown; they appear reversed in the display as they would when viewing a mirror, but are not reversed in the recording.

## NOTE:

The tape remaining indicator does not appear during interface shooting. However, when the remaining time reaches 2 minutes, the indicator appears showing the remaining time: (blinking) (blinking) (blinking) (blinking)

## Brightness Control

You can adjust the brightness of the display by rotating MENU/SET.

### 1 ADJUST BRIGHTNESS

Rotate MENU/SET until the brightness indicator moves and the display reaches its appropriate brightness.

- The brightness indication appears on the display.
- If the viewfinder is pulled out, it is also possible to adjust its brightness.

Zoom in (T: Telephoto)

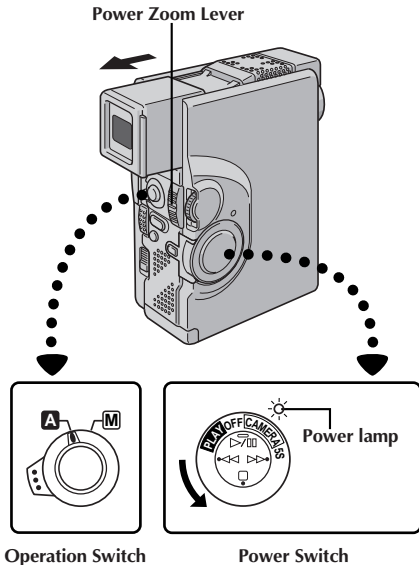
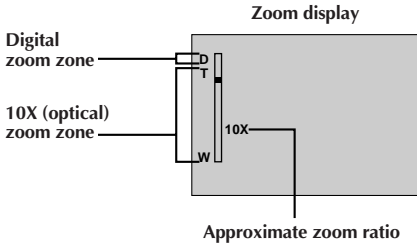
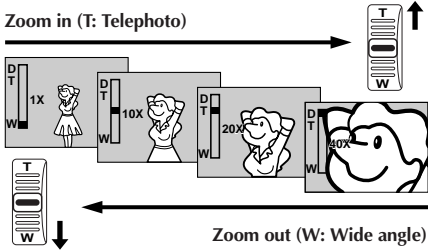
**FEATURE: Zooming****PURPOSE:**

To produce the zoom in/out effect, or an instantaneous change in image magnification.

**OPERATION:****Zoom In**

Slide the Power Zoom Lever towards "T".

**Zoom Out**

Slide the Power Zoom Lever towards "W".

- The further you slide the Power Zoom Lever, the quicker the zoom action.

**NOTES:**

- Focusing may become unstable during Zooming. In this case, set the zoom while in Record-Standby, lock the focus by using the manual focus (☞ pg. 37), then zoom in or out in Record mode.
- In Full Auto mode (when the Operation Switch is set to "A"), zoom magnification of up to 40X is possible. In Manual mode (when the Operation Switch is set to "M"), zooming is possible to a maximum of 100X or can be switched to 10X magnification offered by optical zoom.
- Zoom magnification of over 10X is done through Digital image processing, and is therefore called Digital Zoom.
- During Digital zoom, the quality of image may suffer.
- Digital zoom cannot be used while functions done through Digital image processing (Picture Wipe/Dissolve function, ☞ pg. 32, Video Echo, ☞ pg. 35, etc.) are activated.
- Macro shooting (as close as approx. 5 cm to the subject) is possible when the Power Zoom Lever is set all the way to "W". Also see "TELE MACRO" in the System Menu on page 30.

## NOTE: Recording From The Middle Of A Tape

### Time Code

During recording, a time code is recorded on the tape. This code is to confirm the location of the recorded scene on the tape during playback.

If recording starts from a blank portion, the time code begins counting from "00:00:00" (minute:second:frame). If recording starts from the end of a previously recorded scene, the time code continues from the last time code number.

To perform Random Assemble Editing (☞ pg. 56 – 61), time code is necessary. If during recording a blank portion is recorded partway through the tape, the time code is interrupted. When recording is resumed, the time code starts counting up again from "00:00:00". This means the camcorder may record the same time codes as those existing in a previously recorded scene. To prevent leaving a blank portion on a tape, perform the procedure in "Recording From The Middle Of A Tape" (see below) in the following cases;

- After playing back the recorded tape, when you shoot again.
- When power shuts off during shooting.
- When a tape is removed and re-inserted during shooting.
- When shooting using a partially recorded tape.
- When shooting on a blank portion located partway through the tape.
- When shooting again after already shooting a scene and opening/closing the cassette cover.

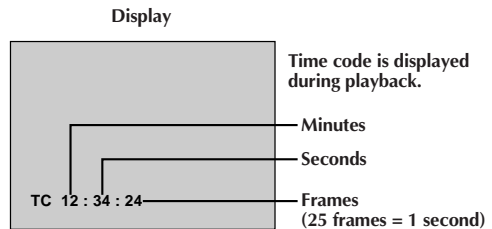

### Recording From The Middle Of A Tape

1. Play back a tape to find the spot at which you want to start recording, then engage the Still Playback mode (☞ pg. 43).
2. Set the Operation Switch to "A" or "M". Then, set the Power Switch to "CAMERA" or "5S" while pressing down the Lock Button and start recording.

### NOTES:

- The Time Code cannot be reset.
- During fast-forwarding and rewinding, time code indication does not move smoothly.

#### When blank portion is recorded on a tape

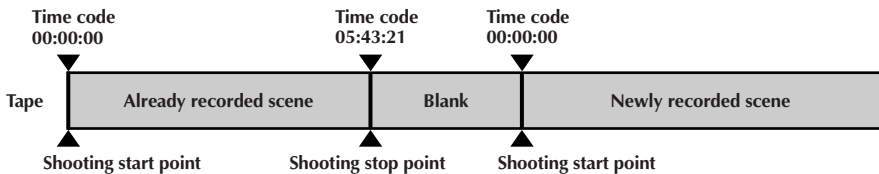

#### Proper recording

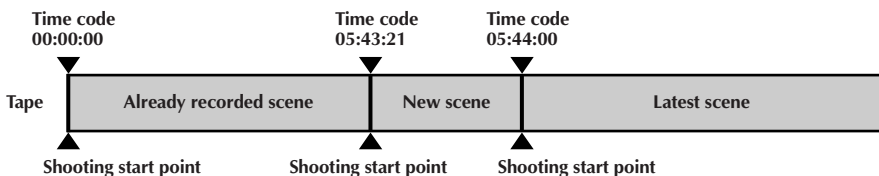

## Displaying The Date And Time During Recording

When the Operation Switch is set to "M", you can choose whether to display the date and time during recording or not. You must first set the date and time ("Date/Time Settings",  pg. 8). Set "DISPLAY" to "ON" in the Date/Time Menu. The Date/Time is always displayed when the Operation Switch is set to "A".

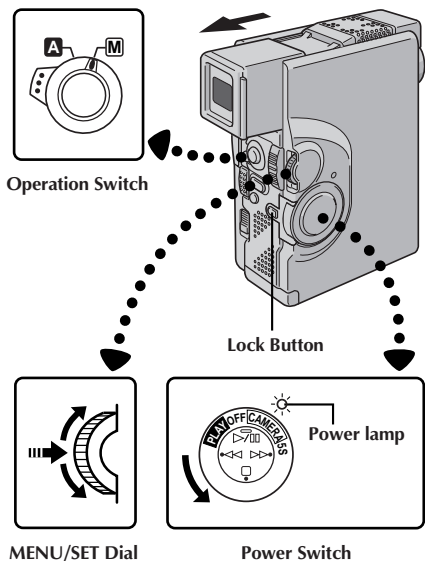

### Display

FOCUS	AUTO
EXPOSURE	AUTO
W. BALANCE	AUTO
FADER	OFF
/ WIPE	
P. AE	OFF
/ EFFECT	
FLASH ADJ.	±0
<b>TO MODE MENU</b>	
END	

Recording Menu

REC MODE	SP
WIDE MODE	OFF
ZOOM	40X
DIS	ON 
GAIN UP	AGC
SELF-TIMER	OFF
FLASH	AUTO
<b>TO DATE/TIME MENU</b>	
TO SYSTEM MENU	
END	

Mode Menu

DATE/TIME	
INDICATION	ON
ON SCREEN	OFF
DISPLAY	ON
DATE / TIME	25 . 12 . 99
	16 : 40
<b>RETURN</b>	

Date/Time Menu

### 1 SELECT OPERATION MODE

Set the Operation Switch to "M". Then, set the Power Switch to "CAMERA" or "5S" while pressing down the Lock Button.

### 2 ACCESS RECORDING MENU

Press MENU/SET. The Recording Menu appears.

### 3 ACCESS MODE MENU

Move the highlight bar to "TO MODE MENU" by rotating MENU/SET. Press it and the Mode Menu appears.

### 4 ACCESS DATE/TIME MENU

Move the highlight bar to "TO DATE/TIME MENU" by rotating MENU/SET. Press it and the Date/Time Menu appears.

### 5 SELECT FUNCTION

Move the highlight bar to "DISPLAY" by rotating MENU/SET, then press it.

### 6 SET FUNCTION PARAMETERS

Cycle through the available settings of the selected functions by rotating MENU/SET and stop when the one you want is displayed. Then press it and the highlight bar automatically moves to "RETURN".

### 7 CLOSE RECORDING MENU

Press MENU/SET twice. Selection is complete and the menu disappears.

## NOTES:

- Connect the camcorder to a TV and set "ON SCREEN" to "ON" in the Date/Time Menu. The display appears on the connected TV.
- Even if "ON SCREEN" is set to "ON", the indications are removed from the TV if "INDICATION" is set to "OFF" ( pg. 21).

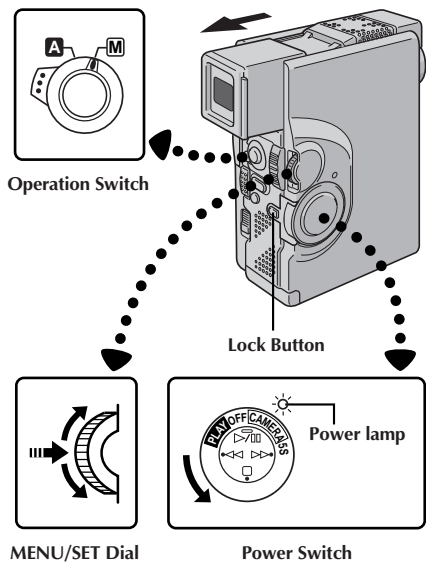

## Display

FOCUS	AUTO
EXPOSURE	AUTO
W. BALANCE	AUTO
FADER	OFF
/ WIPE	
P. AE	OFF
/ EFFECT	
FLASH ADJ.	±0
<b>TO MODE MENU</b>	
END	

## Recording Menu

REC MODE	SP
WIDE MODE	OFF
ZOOM	40X
DIS	ON
GAIN UP	AGC
SELF-TIMER	OFF
FLASH	AUTO
<b>TO DATE/TIME MENU</b>	
TO SYSTEM MENU	
END	

## Mode Menu

DATE/TIME	
INDICATION	ON
ON SCREEN	OFF
DISPLAY	ON
DATE / TIME	25 . 12 . 99
	16 : 40
<b>RETURN</b>	

## Date/Time Menu

## LCD Monitor/Viewfinder Indications

You can make the LCD monitor/Viewfinder indications appear/disappear.

- 1 SELECT OPERATION MODE**  
Set the Operation Switch to "M". Then, set the Power Switch to "CAMERA" or "5S" while pressing down the Lock Button.
- 2 ACCESS RECORDING MENU**  
Press MENU/SET. The Recording Menu appears.
- 3 ACCESS MODE MENU**  
Move the highlight bar to "TO MODE MENU" by rotating MENU/SET. Press it and the Mode Menu appears.
- 4 ACCESS DATE/TIME MENU**  
Move the highlight bar to "TO DATE/TIME MENU" by rotating MENU/SET. Press it and the Date/Time Menu appears.
- 5 SELECT FUNCTION**  
Move the highlight bar to "INDICATION" by rotating MENU/SET, then press it.
- 6 SET FUNCTION PARAMETERS**  
Cycle through the available settings of the selected functions by rotating MENU/SET and stop when the one you want is displayed.  
**OFF:** To make the indications disappear.  
**ON:** To make the indications appear.  
Then press it and the highlight bar automatically moves to "RETURN".
- 7 CLOSE RECORDING MENU**  
Press MENU/SET twice. Selection is complete and the menu disappears.

## NOTES:

- It is impossible to make the tape running indicator "▶▶▶" and warnings etc. disappear from the LCD monitor or the viewfinder. For the indications that can be removed, see pg. 72 and 73.
- If "INDICATION" is set in the Date/Time Menu, "INDICATION" in the Playback Menu will also be set to the same setting (see pg. 45).

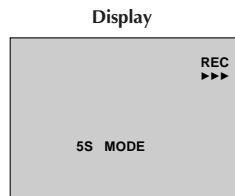
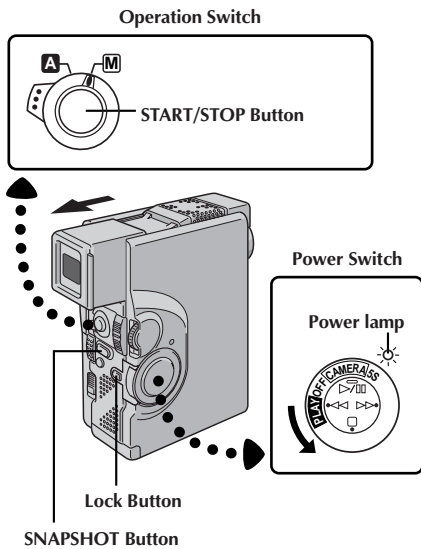

After 5 sec.

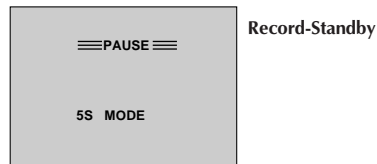

Dissolves during 5 second recording mode

## Scene (5-second recording)

Record a vacation or an important event in 5-second clips to keep the action moving.

### 1 SELECT OPERATION MODE

Set the Operation Switch to "A" or "M", then set the Power Switch to "5S" while pressing down the Lock Button. Pull out the viewfinder fully or open the LCD monitor fully.

- "5S MODE" appears.

### 2 ENGAGE 5S MODE

Press START/STOP. The tally lamp lights and beep sounds to indicate the start of recording, and after 5 seconds the camcorder enters Record-Standby mode.

- If you press START/STOP again within 5 seconds after recording starts, Record-Standby mode is not engaged.
- If you press and hold START/STOP, recording continues until START/STOP is released.

### 3 END 5S MODE

Set the Power Switch to "CAMERA" or "OFF".

**To Take A Snapshot In The 5-Second Recording Mode . . .**  
 .... instead of pressing START/STOP in step 2, press **SNAPSHOT MODE** as many times as necessary until the desired snapshot indicator is displayed, then press **SNAPSHOT**. The camcorder records a 5-second still (☞ pg. 24). When "SCENE" is set to "ANIM." (☞ pg. 28, 30) this function is not available.

## NOTES:

- When "SCENE" is set to "ANIM." in the System Menu, the 5-second recording mode is not available. Animation recording of a 1/3-second clip is taken instead (☞ pg. 28, 30).
- While the 5-second recording mode is activated, Fade/Wipe effects (☞ pg. 33) and Programme AE with special effects (☞ pg. 35) cannot be performed. However, when "SCENE" is set to "5SD" in the System Menu (☞ pg. 30), the Dissolve function is available (see below).

### Dissolves during 5 second recording mode

Set "SCENE" to "5SD" in the System Menu (☞ pg. 28, 30). "5SD MODE" appears in step 1. Record one 5-second clip, and the image at the end of the clip is stored. If you record the next clip within 5 minutes, the previous scene dissolves as the new scene appears.

- If you turn the power off, the stored image will be lost.

## Self-Timer

Once the camcorder is set, the camcorder operator can become part of the scene in a more natural way, adding the final touch to a memorable picture.

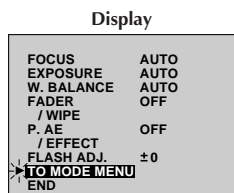
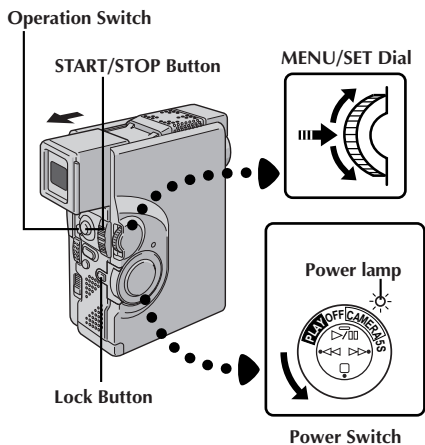

Recording Menu

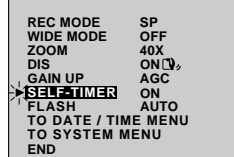

Mode Menu

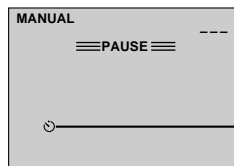

Self-Timer indication

After 15 sec.

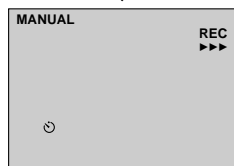

During recording

When START/STOP or SNAPSHOT is pressed, the tally lamp changes as shown:

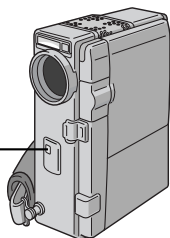

1

### SELECT OPERATION MODE

Set the Operation Switch to "M". Then, set the Power Switch to "CAMERA" (or "5S") while pressing down the Lock Button. Pull out the viewfinder fully or open the LCD monitor fully.

- You can tilt the LCD monitor upward to 180 degrees so that it faces forward and view yourself while self-recording with the viewfinder pushed back.

2

### ACCESS RECORDING MENU

Press MENU/SET. The Recording Menu appears.

3

### ACCESS MODE MENU

Move the highlight bar to "TO MODE MENU" by rotating MENU/SET. Press it. The Mode Menu appears.

4

### SET SELF-TIMER

Move the highlight bar to "SELF-TIMER" by rotating MENU/SET. Press it and the parameter is highlighted. Rotate MENU/SET until "ON" appears. Press it twice to exit from the Recording Menu.

5

### ENGAGE SELF-TIMER MODE

Press START/STOP.

- After 15 seconds, the beep sounds and recording starts.

6

### STOP SELF-TIMER RECORDING

Press START/STOP.

- The camcorder re-enters Record-Standby mode.

7

### END SELF-TIMER RECORDING

Set the Operation Switch to "A" or set the Power Switch to "OFF". "SELF-TIMER" is automatically set back to "OFF".

### To Take A Snapshot In The Self-Timer Mode. . .

.... in step 5, press SNAPSHOT instead of START/STOP. After that, the camcorder enters the Record-Standby mode.

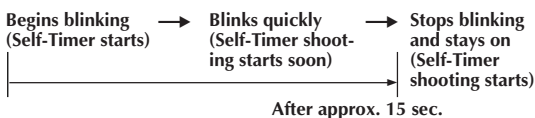

## Snapshot

Use your camcorder like a regular camera and take a snapshot, or several of them in succession.

### SNAPSHOT MODE SELECTION

#### 1 SELECT OPERATION MODE

Set the Operation Switch to "A" or "M". Then, set the Power Switch to "CAMERA" while pressing down the Lock Button. Pull out the viewfinder fully or open the LCD monitor fully.

#### 2 SELECT SNAPSHOT MODE

Choose the appropriate mode from among the 5 Snapshot modes by pressing **SNAPSHOT MODE**. Press **SNAPSHOT MODE** as many times as necessary until the desired snapshot mode indicator is displayed.

### SNAPSHOT RECORDING

#### 1 TAKE SNAPSHOT

Press **SNAPSHOT**.

- When the "⚡" flash ready indicator is displayed, the flash fires.

*If you press during Record-Standby . . .*

.... "PHOTO" appears and a still image will be recorded for approx. 6 seconds, then the camcorder re-enters the Record-Standby mode.

*If you press during Recording . . .*

.... "PHOTO" appears and a still image will be recorded for approx. 5 seconds, then the normal recording resumes.

#### Motor Drive Mode

Keeping **SNAPSHOT** pressed provides an effect similar to serial photography. (The interval between the still images: approx. 1 second.)

The flash fires only during the first snapshot (☞ pg. 26).

#### To Remove The Shutter Sound . . .

.... when you don't want to hear the shutter sound, set BEEP/TALLY to "OFF" in the System Menu (☞ pg. 28, 30). Though the sound is not heard from the speaker, it is recorded on the tape.

### NOTES:

- Even if "MULTI-4" or "MULTI-9" is engaged, Snapshot recording will be performed in the FULL mode during Digital Zoom. However, the flash will not fire.
- If Snapshot recording is not possible, "PHOTO" blinks when **SNAPSHOT** is pressed.
- Even if Programme AE with special effects (☞ pg. 34) is engaged, certain modes of Programme AE with special effects are disabled during Snapshot recording. In such a case, the icon blinks.
- During playback as well, all Snapshot modes are available. The shutter sound is not heard.
- To reduce the Red-Eye effect of the subject's eyes when the flash fires, ☞ pg. 26.
- When a cable or headphone set is connected to the AV OUT connector, the shutter sound is not heard from the speaker, however it is recorded onto the tape.

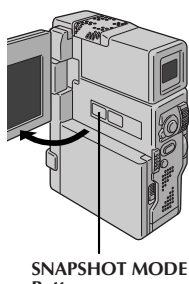
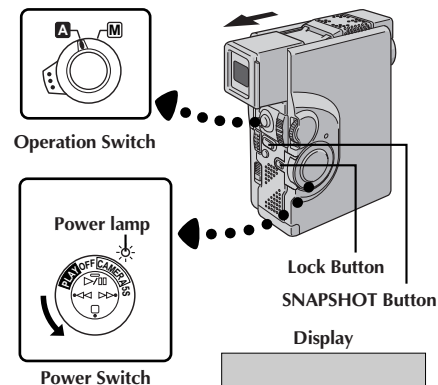

PIN-UP  
Pin-Up mode\*



FRAME  
Snapshot mode with  
frame\*



FULL  
Snapshot mode with  
no frame\*

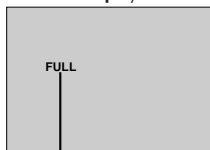
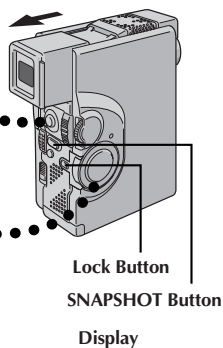

Snapshot mode



During snapshot

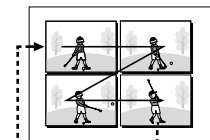

MULTI-4  
Multi-Analyser 4

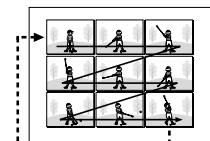

MULTI-9  
Multi-Analyser 9

\*: There is a momentary camera shutter-type blackout together with the sound effect of a shutter closing, which is recorded together with the image.



## Multi Screen Mode

The screen is divided into 9 quadrangles, with the scene you are aiming at appearing in each one. This 9-quadrangle image can be recorded onto a tape.

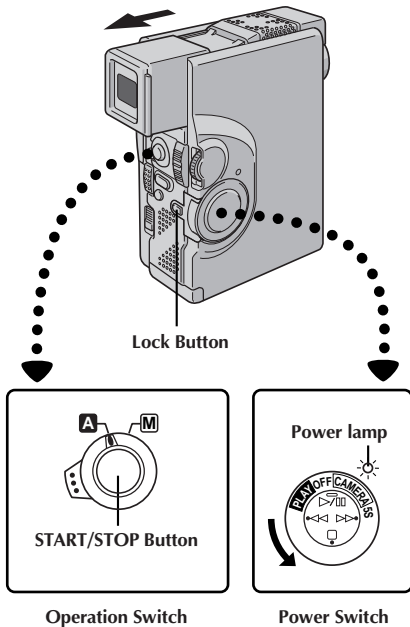

### 1 SELECT OPERATION MODE

Set the Operation Switch to "A" or "M". Then, set the Power Switch to "CAMERA" or "5S" while pressing down the Lock Button.

### 2 ACTIVATE MULTI SCREEN

Press MULTI SCREEN.

[Power Switch: "CAMERA"]

*If you press MULTI SCREEN during recording. . .*

.... the screen will be divided into 9 quadrangles and they will be recorded onto a tape.

[Power Switch: "CAMERA" or "5S"]

*If you press MULTI SCREEN during Record-Standby . . .*

.... the screen will be divided into 9 quadrangles.

Press START/STOP to start recording with 9 quadrangles.

*To Return To The Normal Screen . . . . .*

.... press MULTI SCREEN again.

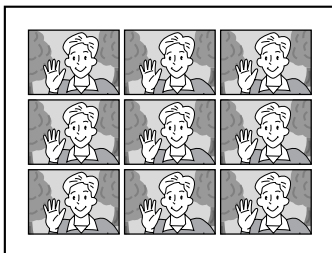
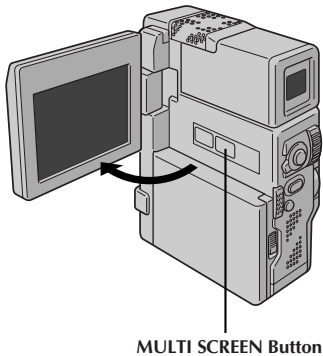

### NOTES:

- In the Multi Screen mode, it is not possible to bring up the Menu Screen.
- During Digital Zoom, the Multi Screen mode is not available.
- The Multi Screen mode is available during playback as well.



Multi Screen mode

## Snapshot Flash (Auto Flash)

In Full Auto or Manual mode, when "FLASH" is set to "AUTO" or "AUTO  " in the Mode Menu, the flash automatically fires if it's dark (  appears) when a snapshot is taken in Record-Standby.

By setting "FLASH" to "ON" or "OFF" in the Mode Menu, the flash can be activated or deactivated on demand. To reduce the Red-Eye effect in the subject's eyes, it is recommended that you set "FLASH" to "AUTO  ". The flash automatically fires using this function when it is dark.

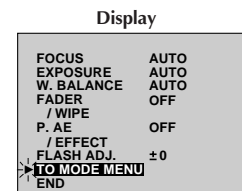
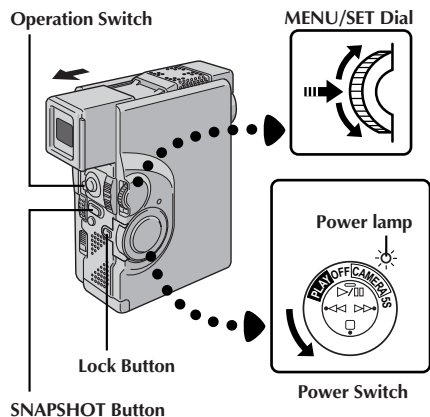

Recording Menu

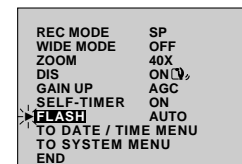

Mode Menu

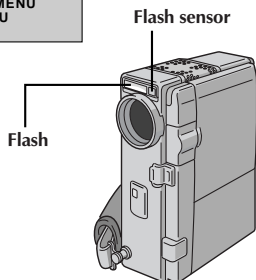

### 1 ENGAGE RECORD-STANDBY

Set the Operation Switch to "A" or "M". Then, set the Power Switch to "CAMERA" or "5S" while pressing down the Lock Button. Pull out the viewfinder fully or open the LCD monitor fully.

*If the Operation Switch is set to "A" . . .*

.... go to step 6.

*If the Operation Switch is set to "M" . . .*

.... go to step 2.

### 2 ACCESS RECORDING MENU

Press MENU/SET. The Recording Menu appears.

### 3 ACCESS MODE MENU

Move the highlight bar to "TO MODE MENU" by rotating MENU/SET. Press it. The Mode Menu appears.

### 4 SELECT FUNCTION

Rotate MENU/SET to move the highlight bar to "FLASH", then press it.

### 5 SELECT FUNCTION PARAMETERS

Rotate MENU/SET to display the desired parameter ("AUTO", "ON", "OFF" or "AUTO  ") and press it. The parameter stops blinking and setting is complete. Press MENU/SET. The normal screen reappears.





### 6 TAKE SNAPSHOT

Press SNAPSHOT.

*If "AUTO  " Is Selected In The Mode Menu . . .*

.... the  Red-Eye reduction indicator lights, then press SNAPSHOT. The flash fires twice. The first flash is for reduction of the human eye's red reflection and the second flash is for the actual recording.

## NOTES:

- Do not fire the flash at a person at short range.
- In Multi-Analyser 4 or Multi-Analyser 9, the flash is disabled (  pg. 24).
- The flash does not fire when the flash is set to "OFF" on the Mode Menu and also when the battery remaining power is low. Moreover, the flash does not fire when it is set to "AUTO" on the Mode Menu with GAIN UP set to "OFF" (  pg. 29) and with Programme AE with special effects set to "TWILIGHT" (  pg. 34).
- When taking several snapshots in succession (Motor Drive Mode), the flash fires only during the first one.
- Although images shot with a flash tend to look whiter than they actually are, to compensate for this the camcorder automatically darkens the picture when using the flash. When shooting a subject at a distance where the flash light cannot reach (over approx. 2 m), set the flash to "OFF" to prevent the picture from becoming too dark.
- The colour tone changes depending on the background lighting conditions, such as under fluorescent or halogen lamps.
- When you want to change the brightness of the flash, refer to "Flash Brightness Adjustment" (  pg. 27).
- While charging the flash,  blinks and the flash will not fire. Although noise may appear, this is not a malfunction and is not recorded. It can take up to ten seconds to charge the flash.

## Flash Brightness Adjustment

When a snapshot (pg. 24) is taken in the dark the camcorder fires the flash (pg. 26) and adjusts the brightness automatically. You can also adjust the flash brightness manually. When you find that the snapshots you took look too bright or too dark, adjust it manually.

### 1 SELECT OPERATION MODE

Set the Operation Switch to "M". Then, set the Power Switch to "CAMERA" or "5S" while pressing down the Lock Button. Pull out the viewfinder fully or open the LCD monitor fully.

### 2 ACCESS RECORDING MENU

Press MENU/SET. The Recording Menu appears.

### 3 SELECT FUNCTION

Rotate MENU/SET to move the highlight bar to "FLASH ADJ.", then press it. The parameter blinks.

### 4 ADJUST BRIGHTNESS OF FLASH

Rotating MENU/SET upward increases the number of the brightness adjustment and rotating MENU/SET downward decreases it.

- The adjustment range is from -3 to +3.

### 5 ACTIVATE BRIGHTNESS OF FLASH

Press MENU/SET twice. The flash brightness adjustment is complete and the normal screen reappears.

## NOTES:

- When the battery power is low or when "FLASH" is set to "OFF" in the Mode Menu, the "FLASH ADJ." setting cannot be changed.
- When you change the subject you are shooting or the shooting location, set it back to  $\pm 0$  as described in step 4 and take a snapshot to check the flash brightness. After doing this adjust to your desired brightness.

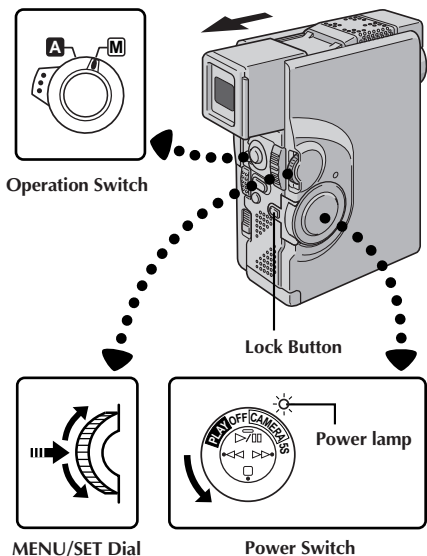

#### Display

#### Recording Menu

FOCUS	AUTO
EXPOSURE	AUTO
W. BALANCE	AUTO
FADER	OFF
/ WIPE	
P. AE	OFF
/ EFFECT	
▶ FLASH ADJ.	$\pm 0$
TO MODE MENU	
END	

FOCUS	AUTO
EXPOSURE	AUTO
W. BALANCE	AUTO
FADER	OFF
/ WIPE	
P. AE	OFF
/ EFFECT	
▶ FLASH ADJ.	$\pm 2$
TO MODE MENU	
END	

MANUAL	
$\pm 2$	

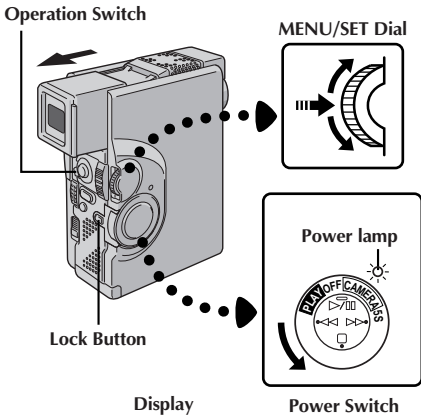

Display

▶ FOCUS	MANUAL
EXPOSURE	AUTO
W. BALANCE	AUTO
FADER / WIPE	OFF
P. AE	OFF
/ EFFECT	FLASH ADJ. ±0
TO MODE MENU	END

Recording Menu

▶ REC MODE	SP OFF
WIDE MODE	OFF
ZOOM	40X ON(L)
DIS	AGC OFF
GAIN UP	SELF-TIMER OFF
FLASH	TO DATE / TIME MENU
TO SYSTEM MENU	END

Mode Menu

DATE/TIME	
▶ INDICATION	ON
ON SCREEN	OFF
DISPLAY	25. 12. 99
DATE / TIME	16 : 40
RETURN	

Date/Time Menu

SYSTEM MENU	
▶ TELE MACRO	OFF
SCENE	OFF
BEEP / TALLY	ON
WIND CUT	OFF
SOUND MODE	32kHz
ID NUMBER	06
DEMO. MODE	OFF
RETURN	

System Menu

FOCUS	MANUAL
EXPOSURE	AUTO
W. BALANCE	AUTO
FADER / WIPE	OFF
P. AE	OFF
/ EFFECT	FLASH ADJ. ±0
TO MODE MENU	END

REC MODE	SP OFF
WIDE MODE	OFF
ZOOM	40X ON(L)
DIS	AGC OFF
GAIN UP	SELF-TIMER OFF
FLASH	TO DATE / TIME MENU
TO SYSTEM MENU	END

Normal Screen

## Using Menu For Detailed Adjustment

This camcorder is equipped with an easy-to-use, on-screen menu system that simplifies many of the more detailed camcorder settings.

1

### SELECT OPERATION MODE

Set the Operation Switch to "M". Then, set the Power Switch to "CAMERA" or "5S" while pressing down the Lock Button. Pull out the viewfinder fully or open the LCD monitor fully.

2

### ACCESS RECORDING MENU

Press MENU/SET. The Recording Menu appears.

3

### SELECT FUNCTION

Rotate MENU/SET to move the highlight bar to the desired function.

- If the setting you want cannot be found in the Menu Screen, place the highlight bar on "END", then go to step 7.

4

### MAKE SETTING

Press MENU/SET. The setting procedure depends on the function you select.

*If you select "FOCUS", "EXPOSURE", "W.BALANCE", "FADER/WIPE", "P.AE/EFFECT" or "FLASH ADJ." ...*

..... see respective pages (FOCUS: [pg. 37](#), EXPOSURE: [pg. 38](#), W.BALANCE: [pg. 40](#), FADER/WIPE: [pg. 31](#), P.AE/EFFECT: [pg. 34](#), FLASH ADJ.: [pg. 27](#)) and do each procedure from step 4.

*If you select "TO MODE MENU" ...*

..... the Mode Menu appears. Go to step 5.

5

### SELECT FUNCTION PARAMETERS IN MODE MENU

Rotate MENU/SET to move the highlight bar to the desired function and press it.

*If you select a function other than "TO DATE/TIME MENU" or "TO SYSTEM MENU" ...*

..... each function's parameter starts blinking. Rotate MENU/SET until the desired parameter appears. Go to step 7.

*If you select "TO DATE/TIME MENU" ...*

..... the Date/Time Menu appears. Go to step 6.

*If you select "TO SYSTEM MENU" ...*

..... the System Menu appears. Go to step 6.

6

### SELECT FUNCTION PARAMETERS IN DATE/TIME MENU OR SYSTEM MENU

Rotate MENU/SET to move the highlight bar to the desired function, then press it.

*If you select "DATE/TIME" ... [pg. 8](#)*

*If you select other functions ...*

..... rotate MENU/SET until the desired parameter appears, then press it. The highlight bar automatically moves to "RETURN". Go to step 7.

7

### CLOSE MENU SCREEN

Press MENU/SET as many times as necessary to return to the normal screen.

## Recording Menu Explanations

<b>FOCUS</b>	Refer to “Focusing” (☞ pg. 36, 37).
<b>EXPOSURE</b>	Refer to “Exposure Control” and “Iris Lock” (☞ pg. 38, 39).
<b>W.BALANCE</b>	Refer to “White Balance Adjustment” and “Manual White Balance Operation” (☞ pg. 40, 41).
<b>FADER/WIPE</b>	Refer to “Fade/Wipe Effects” (☞ pg. 31 – 33).
<b>P.AE/EFFECT</b>	Refer to “Programme AE With Special Effects” (☞ pg. 34, 35).
<b>FLASH ADJ.</b>	Refer to “Flash Brightness Adjustment” (☞ pg. 27).
<b>TO MODE MENU</b>	Refer to “Mode Menu Explanations” below.

## Mode Menu Explanations

<b>REC MODE</b>		Allows you to set the recording mode (SP or LP) depending on your preference (☞ pg. 10).
<b>WIDE MODE</b>	<b>OFF</b>	Select “OFF” when you want to use neither “SQUEEZE” nor “CINEMA”.
	<b>SQUEEZE</b> ☑	For playback on TVs with an aspect ratio of 16:9. Naturally expands the image to fit the screen without distortion. ☑ appears. When using this mode, refer to your wide-screen TV’s instruction manual. During playback/recording on 4:3 TVs/LCD monitor/viewfinder, the image is elongated vertically.
	<b>CINEMA</b> ☐	Inserts black bands at the top and bottom of the screen. During playback on wide-screen TVs, the black bands at the top and bottom of the screen are cut and the screen ratio becomes 16:9. When using this mode, refer to your wide-screen TV’s instruction manual. During playback/recording on 4:3 TVs/LCD monitor/viewfinder, black bands are inserted at the top and bottom of the screen and the image appears like a letterboxed 16:9 movie.
<b>ZOOM</b>	<b>10X</b>	When set to “10X” while using digital zoom, the zoom magnification will reset to 10X since digital zoom will be disengaged.
	<b>40X</b>	Allows you to use the Digital Zoom. By digitally processing and magnifying images, zooming is possible from 10 times (the optical zoom limit), to a maximum of 40 times digital magnification.
	<b>100X</b>	Allows you to use the Digital Zoom. By digitally processing and magnifying images, zooming is possible from 10 times (the optical zoom limit), to a maximum of 100 times digital magnification.
<b>DIS</b>	<b>ON</b> ☑	To compensate for unstable images caused by camera-shake, particularly at high magnification. <b>NOTES:</b> <ul style="list-style-type: none"> <li>• Accurate stabilisation may not be possible if hand shake is excessive, or under the following conditions: <ul style="list-style-type: none"> <li>• When shooting subjects with vertical or horizontal stripes.</li> <li>• When shooting dark or dim subjects.</li> <li>• When shooting subjects with excessive backlighting.</li> <li>• When shooting scenes with movement in various directions.</li> <li>• When shooting scenes with low-contrast backgrounds.</li> </ul> </li> <li>• Switch off the Digital Image Stabiliser (DIS) when recording with the camcorder on a tripod.</li> <li>• The “☑” indicator appears blinking if the Stabiliser cannot be used.</li> </ul>
	<b>OFF</b>	
<b>GAIN UP</b>	<b>AGC</b>	This is automatically activated during Full Auto mode. The overall appearance may be grainy, but the image is bright.
	<b>AUTO</b> A☑	The shutter speed is automatically adjusted (1/25 — 1/200 sec.). Shooting a subject in low or poor lighting at 1/25 sec. shutter speed provides a brighter image than in the AGC mode, but the subject’s movements are not smooth or natural. When set to this mode, “A☑” is displayed.
	<b>OFF</b>	Allows you to shoot dark scenes with no picture brightness adjustment.
<b>SELF-TIMER</b>		Refer to “Self-Timer” (☞ pg. 23).
<b>FLASH</b>		Refer to “Snapshot Flash (Auto Flash)” (☞ pg. 26).
<b>TO DATE/TIME MENU</b>		Refer to “Date/Time Menu Explanations” (☞ pg. 30).
<b>TO SYSTEM MENU</b>		Refer to “System Menu Explanations” (☞ pg. 30).

☐ : Factory-preset

## Date/Time Menu Explanations

INDICATION	ON	Makes all the indications appear in the camcorder (☞ pg. 21).
	OFF	Keeps all the indications (except the tape running indicator, warnings, etc.) from appearing in the camcorder (☞ pg. 21).
ON SCREEN	OFF	Keeps the camcorder's display from appearing on the connected TV screen.
	ON	Makes the camcorder's display appear on screen when the camcorder is connected to a TV.
DISPLAY	ON	Makes the date/time settings appear in the camcorder (☞ pg. 20).
	OFF	Keeps the date/time settings from appearing in the camcorder.
DATE/TIME		Allows you to set the current date and time (☞ pg. 8).

## System Menu Explanations

TELE MACRO	OFF	Usually the distance to a subject where the lens is in focus depends on the zoom magnification. Unless there is a distance more than 1 m to the subject, the lens is out of focus at the maximum telephoto setting. When set to "ON", you can shoot a subject as large as possible at a distance of approx. 60 cm.
	ON	<ul style="list-style-type: none"> <li>Depending on the zoom position, the lens may go out of focus.</li> </ul>
SCENE	5S	☞ pg. 22.
	5SD	☞ pg. 22.
	ANIM.	Allows you to record a 1/3-second clip. By using an inanimate object and changing its position between shots, you can record the subject as though it is moving (☞ pg. 22).
BEEP/TALLY	ON	The tally lamp comes on to signal the start of recording. The beep sounds when the power is turned on or off, and at the beginning and end of recording. Also to activate the shutter sound effect (☞ pg. 24).
	OFF	The tally lamp remains off at all times. Even though not heard while shooting, shutter sound is recorded on the tape.
WIND CUT	OFF	Disengages the function which cuts down on noise created by wind.
	ON	<p>Helps cut down on noise created by wind.</p> <ul style="list-style-type: none"> <li>"" appears.</li> <li>The quality of the sound will change. This is normal.</li> </ul>
SOUND MODE	32 kHz	Enables recording of stereo sound on four separate channels, and is recommended for use when performing audio dubbing.
	48 kHz	Enables recording of stereo sound on two separate channels.
ID NUMBER		This number is necessary when connecting the camcorder to a device such as a computer using the J terminal (JLIP). The numbers range from 01 to 99. Factory setting is 06.
DEMO. MODE	OFF	Automatic demonstration will not take place.
	ON	<p>Demonstrates certain functions such as Programme AE with special effects, etc., and can be used to confirm how these functions operate. When "DEMO. MODE" is set to "ON" and the Recording Menu is closed, demonstration starts.</p> <p><b>NOTES:</b></p> <ul style="list-style-type: none"> <li>If a tape is in the camcorder, the demonstration cannot be turned on.</li> <li>By turning off the camcorder, "DEMO. MODE" is set to "OFF" automatically.</li> </ul>

 : Factory-preset

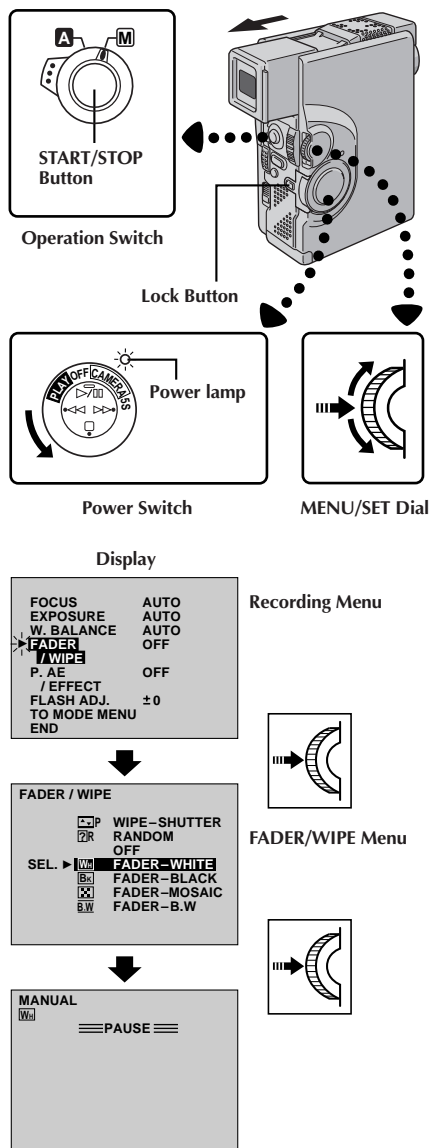
[Ex.: **Wh** FADER - WHITE]

Fade-in



Fade-out

## Fade/Wipe Effects

### IMPORTANT:







If certain modes of Programme AE with special effects (pg. 34) are activated, some Fade/Wipe Effects cannot be used. If you select a Fade/Wipe Effect that is unusable in the current situation, the indication blinks.

These effects let you make pro-style scene transitions. Use these to spice up the transition from one scene to the next. You can also vary transitions from scene to scene.

### EFFECT SELECTION

- 1 SELECT OPERATION MODE**  
Set the Operation Switch to "M". Then set the Power Switch to "CAMERA" while pressing down the Lock Button. Pull out the viewfinder fully or open the LCD monitor fully.
- 2 ACCESS RECORDING MENU**  
Press MENU/SET. The Recording Menu appears.
- 3 ACCESS "FADER/WIPE" MENU**  
Rotate MENU/SET to move the highlight bar to "FADER/WIPE", then press it.
- 4 SELECT EFFECT**  
Rotate MENU/SET to move the highlight bar to the desired function, then press it.
  - The FADER/WIPE Menu disappears and the effect is reserved. The indicator representing the selected effect appears.

### FADE/WIPE SELECTION

(**Wh**, **Bk**, **X**, **B.W**, , , , , ,  and **R**)

A scene gradually appears on a black, white, or black-and-white screen (Fade-in or Wipe-in); or disappears, leaving a black, white, or black-and-white screen (Fade-out or Wipe-out).

Fade or Wipe works when recording is started or when you stop recording.

Before the following step, perform the above steps 1 through 4.

### 5 START OR END RECORDING

Press START/STOP to activate Fade-in/out or Wipe-in/out.

### NOTE:

 pg. 32.

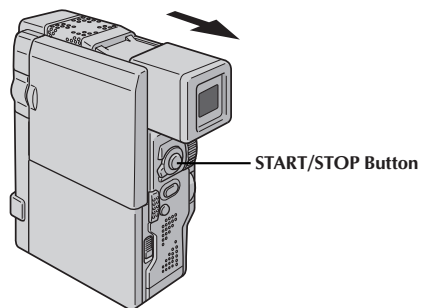

Previous scene end



[Ex.: P WIPE - SCROLL]

Within 5 minutes . . .



Wipe-in

## PICTURE WIPE OR DISSOLVE SELECTION

( P, P, P, P, P, P and P)

Combine the Picture Wipe and Dissolve functions for a professional transition effect. There are 6 Picture Wipe effects and 1 Dissolve effect. The Picture Wipe or Dissolve works when recording is started.

**Before the following steps, perform steps 1 through 4 on pg. 31.**

## 5 STORE SCENE IN MEMORY

Engage the Record-Standby mode.

*If you select Picture Wipe/Dissolve during recording . . .*

.... press **START/STOP** when one scene is finished. The point at which the scene ended is stored in memory.

*If you select Picture Wipe/Dissolve during Record-Standby mode . . .*

.... press **START/STOP** to start recording and press it again when one scene is finished. The point at which the scene ended is stored in memory.

*If you select Picture Wipe/Dissolve during Record-Standby mode after performing a Picture Wipe/Dissolve . . .*

.... the point at which the scene ended is already stored in memory.

## 6 START RECORDING



























If you start recording a new scene within 5 minutes of the end of the previous recording (without having turned the camcorder's power off), the previous scene wipes out, revealing the new scene.

## NOTES:

- You can extend the length of a Fade or Wipe by pressing and holding **START/STOP**.
- If the power is turned off after a scene is finished recording, the stored point is erased. This disables the Picture Wipe/Dissolve combination. When this happens, the Picture Wipe/Dissolve indicator blinks. Try recording again, but do not turn the power off when you are finished. Please be advised that power also shuts off automatically if 5 minutes elapse in the Record-Standby mode.
- The sound at the end of the last recorded scene is not stored.



## Fader And Wipe Menu

Menu	Effect
 <b>FADER — WHITE</b>	Fade in or out with a white screen.
 <b>FADER — BLACK</b>	Fade in or out with a black screen.
 <b>FADER — MOSAIC</b>	Fade in or out with a full-screen mosaic effect.
 <b>FADER — B.W</b>	Fade in to a colour screen from a black and white screen, or fade out from colour to black and white.
 <b>WIPE — CORNER</b>	Wipe in on a black screen from the upper right to the lower left corner, or wipe out from lower left to upper right, leaving a black screen.
 <b>WIPE — WINDOW</b>	The scene starts in the centre of a black screen and wipes in toward the corners, or comes in from the corners, gradually wiping out to the centre.
 <b>WIPE — SLIDE</b>	Wipe in from right to left, or wipe out from left to right.
 <b>WIPE — DOOR</b>	Wipe in as the two halves of a black screen open to the left and right, revealing the scene, or wipe out and the black screen reappears from left and right to cover the scene.
 <b>WIPE — SCROLL</b>	The scene wipes in from the bottom to the top of a black screen, or wipes out from top to bottom, leaving a black screen.
 <b>WIPE — SHUTTER</b>	Wipe in toward the centre of a black screen from the top and bottom, or wipe out from the centre toward the top and bottom, leaving a black screen.
 <b>P DISSOLVE</b>	The new scene gradually appears as the old one gradually disappears.
 <b>P WIPE — CORNER</b>	The new scene wipes in over the previous one from the upper right corner to the lower left corner.
 <b>P WIPE — WINDOW</b>	The next scene gradually wipes in from the centre of the screen toward the corners, covering the previous scene.
 <b>P WIPE — SLIDE</b>	The next scene gradually wipes in over the previous one from right to left.
 <b>P WIPE — DOOR</b>	The previous scene wipes out from the centre to the right and left, like a door being pushed open to reveal the next scene.
 <b>P WIPE — SCROLL</b>	The new scene wipes in over the last one from the bottom of the screen to the top.
 <b>P WIPE — SHUTTER</b>	The new scene wipes in over the previous one from the centre toward the top and bottom of the screen.
 <b>R RANDOM</b>	When this function is activated, the camcorder randomly selects the effect used in scene transition (from  ,  ,  ,  ,  ,  ,  ,  , and  ). The Picture Wipe/Dissolve function is not available.

## Programme AE With Special Effects

### IMPORTANT:

If certain Fades or Wipes (pg. 33) are activated, some modes of Programme AE with special effects cannot be used. If you select a mode that is unusable in the current situation, the mode's symbol blinks.

You can choose any one of the effects from the P.AE/EFFECT Menu.

#### 1 SELECT OPERATION MODE

Set the Operation Switch to "M". Then set the Power Switch to "CAMERA" while pressing down the Lock Button. Pull out the viewfinder fully or open the LCD monitor fully.

#### 2 ACCESS RECORDING MENU

Press MENU/SET. The Recording Menu appears.

#### 3 ACCESS "P.AE/EFFECT" SELECT MENU

Rotate MENU/SET to move the highlight bar to "P.AE/EFFECT", then press it.

#### 4 SELECT MODE

Move the highlight bar to the desired mode by rotating MENU/SET, then press it.

- The P.AE/EFFECT Menu disappears and the selected mode is activated. The symbol of the selected mode appears.

#### 5 DISABLE MODE

To turn off the selected mode, re-access the P.AE/EFFECT Menu and move the highlight bar to "OFF" by rotating MENU/SET. Then press it.

### NOTE:

Programme AE with special effects can be changed during recording or during Record-Standby.

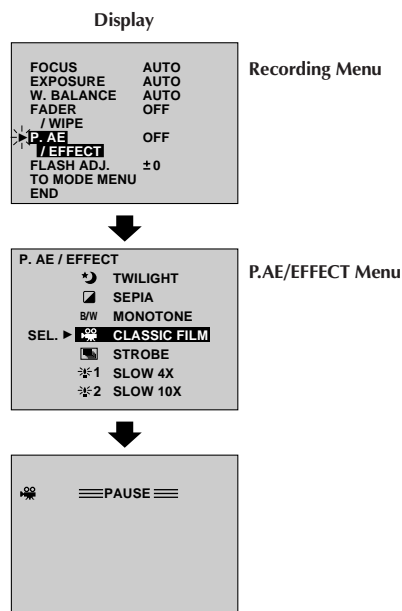
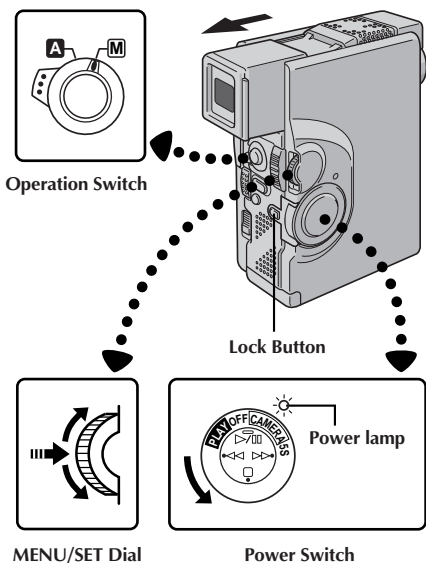

The indicator for the selected mode appears, and the selected mode is engaged.



### SHUTTER (Variable Shutter Speed)

**1/50**—The shutter speed is fixed at 1/50th of a second. Black bands that usually appear when shooting a TV screen become narrower.

**1/100**—The shutter speed is fixed at 1/100th of a second. The flickering that occurs when shooting under a fluorescent light or mercury-vapour lamp is reduced.

**1/250, 1/500**—These settings allow fast-moving images to be captured one frame at a time, for vivid, stable slow-motion playback. The faster the shutter speed, the darker the picture becomes. Use the shutter function under good lighting conditions.

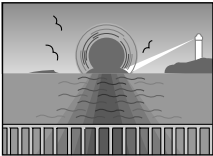

### TWILIGHT

Makes evening scenes look more natural. White Balance (pg. 40) is initially set to , but can be changed to your desired setting. When Twilight is chosen, the camcorder automatically adjusts the focus from approx. 10 m to infinity. From less than 10 m, adjust the focus manually.



### SEPIA

Recorded scenes have a brownish tint like old photos. Combine this with the Cinema mode for a classic look.

### B/W MONOTONE

Like classic black and white films, your footage is shot in B/W. Used together with the Cinema mode, it enhances the “classic film” effect.



### CLASSIC FILM

Gives recorded scenes a strobe effect.



### STROBE

Your recording looks like a series of consecutive snapshots.

### SLOW (Slow Shutter)

You can light dark subjects or areas even brighter than they would be under good natural lighting.



**1 SLOW 4X**

The Shutter Speed is set to 1/12.5th of a second to quadruple the sensitivity.



**2 SLOW 10X**

The Shutter Speed is set to 1/5th of a second to provide 10 times the sensitivity.

### NOTES:

- When using “SLOW”, the image takes on a strobe-like effect.
- Use “SLOW” only in dark areas.
- The Manual Focus indication may appear and flash when “SLOW” is in use.
- If the image is out of focus, adjust manually. It is also recommended that you use a tripod, if possible.



### VIDEO ECHO

Adds a “ghost” to the subject, giving your recording a “fantasy” feeling.

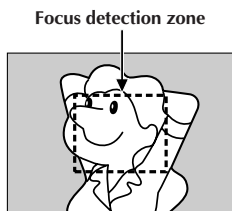

## Focusing

### AUTO FOCUS

The camcorder's Full Range AF system offers continuous shooting ability from close-up (as close as approx. 5 cm to the subject) to infinity. However, correct focus may not be obtainable in the situations listed below (in these cases use manual focusing):

- When two subjects overlap in the same scene.
- When illumination is low.\*
- When the subject has no contrast (difference in brightness and darkness), such as a flat, one-colour wall, or a clear, blue sky.\*
- When a dark object is barely visible in the viewfinder.\*
- When the scene contains minute patterns or identical patterns that are regularly repeated.
- When the scene is affected by sunbeams or light reflecting off the surface of a body of water.
- When shooting a scene with a high-contrast background.

\* The following low-contrast warnings appear blinking:

▲, ▲, ▼ and ☹

### NOTES:

- If the lens is smeared or blurred, accurate focusing is not possible. Keep the lens clean, wiping with a piece of soft cloth if it gets dirty. When condensation occurs, wipe with a soft cloth or wait for it to dry naturally.
- When shooting a subject close to the lens, zoom-out first (☞ pg. 18). If zoomed-in in the auto focus mode, the camcorder could automatically zoom out depending on the distance between the camcorder and the subject. When "TELE MACRO" (☞ pg. 30) is activated, the camcorder will not zoom out automatically.

## MANUAL FOCUS

**NOTE:**

You should already have made the necessary viewfinder adjustments (☞ pg. 11). If you have not, do so before continuing.

**1 SELECT OPERATION MODE**

Set the Operation Switch to "M". Then, set the Power Switch to "CAMERA" or "5S" while pressing down the Lock Button. Pull out the viewfinder fully or open the LCD monitor fully.

**2 ACCESS RECORDING MENU**

Press MENU/SET. The Recording Menu appears.

**3 ACCESS "FOCUS"**

Rotate MENU/SET to move the highlight bar to "FOCUS", then press it.

**4 ACCESS MANUAL FOCUS**

Rotate MENU/SET to display "MANUAL", then press it. The Recording Menu disappears and "FOCUS" is displayed in the upper left corner. The focus is locked at this point.

**5 ADJUST FOCUS**

*To farther subject . . .*

... rotate MENU/SET upward. "▲" appears and blinks. Go to step 6.

*To nearer subject . . .*

... rotate MENU/SET downward. "▼" appears and blinks. Go to step 6.

**6 END ADJUSTMENT OF FOCUS**

Press MENU/SET. Focus adjustment is complete. The indication changes from "FOCUS" to "MANUAL".

• If you want to reset the focus, repeat from step 2.

*To Change To Auto Focus . . .*

... rotate MENU/SET to display "AUTO" then press it in step 4. The manual focus indicators disappear. Or, set the Operation Switch to "A".

**NOTES:**

- After the Power Switch is set to "OFF", Manual Focus is reset to "AUTO".
- Be sure to focus the lens in the maximum telephoto position when you use the Manual Focus mode. If you focus in on a certain subject in the wide-angle position, sharply focused images cannot be obtained when zoomed up because the depth-of-field is reduced at longer focal lengths.
- When the focus level cannot be adjusted any farther or closer, "▲" or "●" will blink.

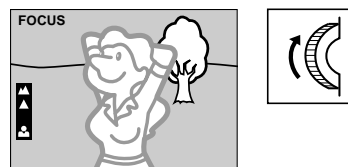
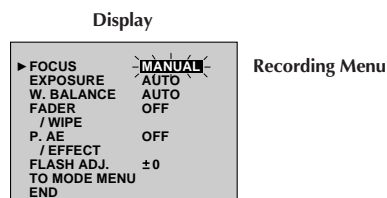
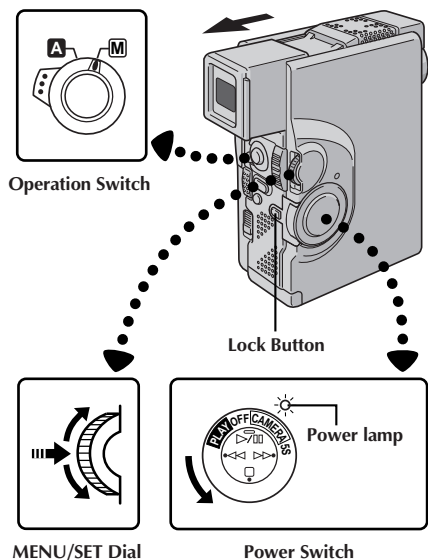

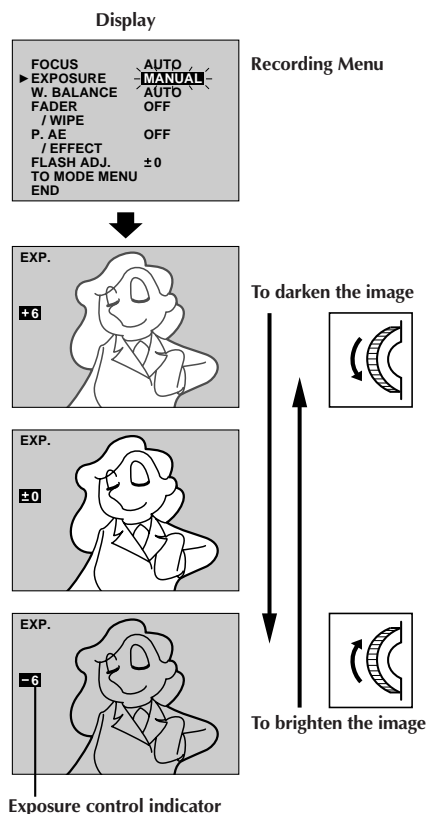
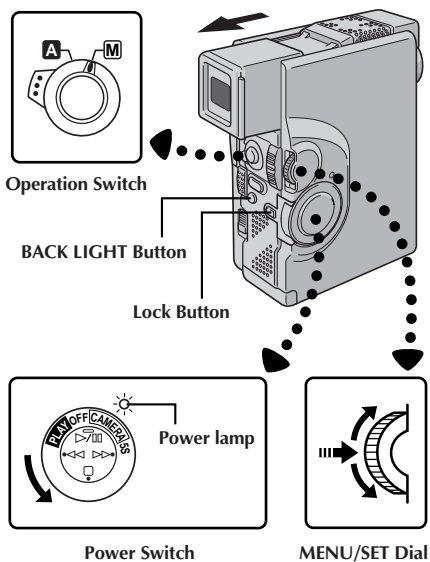

## Exposure Control

This feature automatically adjusts the iris for the best available picture quality, but you can override and make the adjustment manually.

- 1 SELECT OPERATION MODE**  
Set the Operation Switch to "M". Then, set the Power Switch to "CAMERA" or "5S" while pressing down the Lock Button. Pull out the viewfinder fully or open the LCD monitor fully.
- 2 ACCESS RECORDING MENU**  
Press MENU/SET. The Recording Menu appears.
- 3 ACCESS "EXPOSURE"**  
Rotate MENU/SET to move the highlight bar to "EXPOSURE", then press it.
- 4 ACCESS EXPOSURE CONTROL**  
Rotate MENU/SET to display "MANUAL", then press it. The Recording Menu disappears. "EXP." and the highlight bar on the exposure control indicator are displayed.
- 5 ADJUST EXPOSURE**  
*To brighten the image . . .*  
... rotate MENU/SET upward. The exposure control indicator increases (maximum +6).  
Go to step 6.  
*To darken the image . . .*  
... rotate MENU/SET downward. The exposure control indicator decreases (maximum -6).  
Go to step 6.
- 6 END ADJUSTMENT OF EXPOSURE**  
Press MENU/SET. Exposure adjustment is complete. The indication "EXP." changes to "MANUAL" and the highlight bar on the exposure control indicator goes out.  
• If you want to reset the exposure, repeat step 2.



### To Return To Automatic Exposure Control . . .

... rotate MENU/SET to display "AUTO" then press it in step 4. The exposure control indicator disappears. Or set the Operation Switch to "A".

## NOTES:

- After the Power Switch is set to "OFF", Exposure Control is reset to "AUTO".
- Manual exposure adjustment is recommended in the following situations:
  - When shooting using reverse lighting or when the background is too bright.
  - When shooting on a reflective natural background such as at the beach or when skiing.
  - When the background is overly dark or the subject light.

### To Brighten The Subject Quickly . . .

... press BACK LIGHT.  is displayed and the subject is brightened. If pressed again,  disappears and the brightness returns to the previous level. The value shown by the exposure control indicator plus 2 is the back light compensation level. The maximum compensation level is +6. Back light compensation is also available when the Operation Switch is set to "A".

## Operation Switch

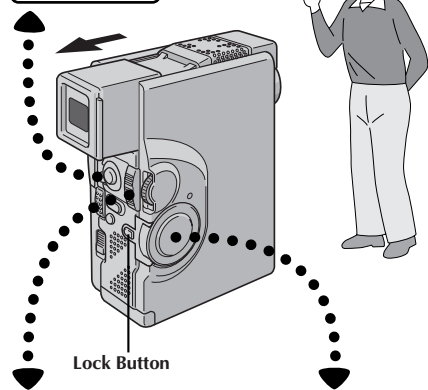
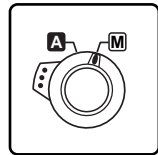

Lock Button

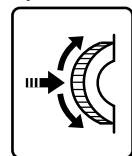

MENU/SET Dial

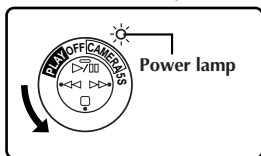

Power Switch

## Display

FOCUS	AUTO
EXPOSURE	MANUAL
W. BALANCE	AUTO
FADER	OFF
/ WIPE	
P. AE	OFF
/ EFFECT	
FLASH ADJ.	±0
TO MODE MENU	
END	

Recording Menu



Iris lock indicator

## Iris Lock

Use this function when shooting a moving subject, when zooming, when the subject changes its distance (thus its size in the LCD monitor or the viewfinder), or when you want to lock the brightness level.

When the subject is close, keep the iris locked. Even when the subject moves away from you, the image will not darken or brighten.

**1 SELECT OPERATION MODE**

Set the Operation Switch to "M". Then, set the Power Switch to "CAMERA" or "5S" while pressing down the Lock Button. Pull out the viewfinder fully or open the LCD monitor fully.

**2 ACCESS RECORDING MENU**

Press MENU/SET. The Recording Menu appears.

**3 ACCESS "EXPOSURE"**

Rotate MENU/SET to move the highlight bar to "EXPOSURE", then press it.

**4 ACCESS EXPOSURE CONTROL**

Rotate MENU/SET to display "MANUAL", then press it. "EXP." is displayed.

**5 CENTRE SUBJECT, LOCK IRIS**

Adjust zoom so that the subject fills the LCD monitor or the viewfinder, then press and hold MENU/SET for over 2 seconds. The exposure control indicator and "L" appear, indicating that the iris is locked. Press MENU/SET. The indication displayed in the upper left corner changes from "EXP." to "MANUAL".

**To Return To Automatic Iris Control . . .**

.... rotate MENU/SET to display "AUTO" then press it in step 4. The exposure control indicator and "L" disappear. Or, set the Operation Switch to "A".

**NOTE:**

*Iris lock is recommended in the following situations:*

- When shooting on a reflective natural background such as at the beach or when skiing.
- When shooting objects under a spotlight.
- When the subject is backing away.
- When zooming.

**To Lock The Exposure Control And The Iris . . .**

.... after step 4, adjust the exposure rotating MENU/SET. Then lock the iris in step 5. For automatic locking, rotate MENU/SET to display "AUTO", then press it in step 4. The iris becomes automatic after about 2 seconds.

**Iris**

Works like the pupil of the human eye. In a well-lit environment, the human pupil contracts to keep too much light from entering. In low lighting, the pupil dilates to allow more light in.

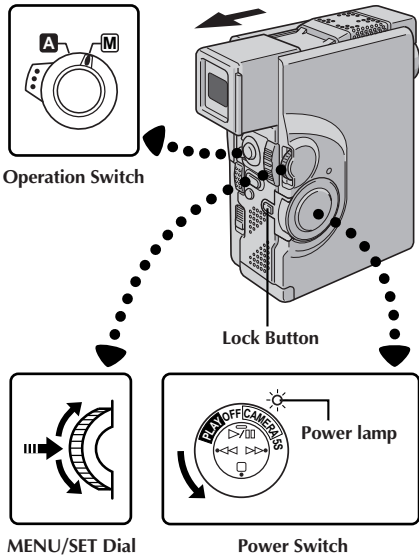

## Display

FOCUS	AUTO
EXPOSURE	AUTO
W. BALANCE	AUTO
FADER	OFF
/ WIPE	
P. AE	OFF
/ EFFECT	
FLASH ADJ.	±0
TO MODE MENU	
*END	

Recording Menu

FOCUS	AUTO
EXPOSURE	AUTO
* W. BALANCE	AUTO
FADER	OFF
/ WIPE	
P. AE	OFF
/ EFFECT	
FLASH ADJ.	±0
TO MODE MENU	
END	

W. BAL.	
AUTO	

White Balance Adjustment

## White Balance Adjustment

A term that refers to the correctness of colour reproduction under various lighting. If the white balance is correct, all other colours will be accurately reproduced. The white balance is usually adjusted automatically. However, the more advanced camcorder operator would prefer to control this function manually and achieve a more professional colour/tint reproduction.

### 1 SELECT OPERATION MODE

Set the Operation Switch to "M". Then, set the Power Switch to "CAMERA" or "5S" while pressing down the Lock Button. Pull out the viewfinder fully or open the LCD monitor fully.

### 2 ACCESS RECORDING MENU

Press MENU/SET. The Recording Menu appears.

### 3 ACCESS "W.BALANCE"

Rotate MENU/SET to move the highlight bar to "W.BALANCE", then press it.

### 4 ACCESS WHITE BALANCE ADJUSTMENT

The Recording Menu disappears. "W.BAL." appears in the upper left corner and the currently selected mode indication is also displayed.

### 5 SET FUNCTION PARAMETERS

Cycle through the available settings of the selected functions by rotating MENU/SET, and stop when the one you want is displayed.

"AUTO" – The white balance is adjusted automatically. This is the factory preset position.

"☑" – When shooting with the white balance already having been set on the subject (☑ pg. 41).

"☀" – When shooting outdoors on a sunny day.

"☁" – When shooting outdoors on a cloudy day.

"☹" – When using a video light or other similar type of lighting.

### 6 CLOSE WHITE BALANCE ADJUSTMENT

Press MENU/SET again. Selection is complete. The indication "W.BAL." changes to "MANUAL".

#### To Return To Automatic White Balance . . .

.... select "AUTO" in step 5. Or, set the Operation Switch to "A".

## NOTE:

White balance cannot be used when Sepia or Monotone (☑ pg. 35) is activated.



## Manual White Balance Operation

If the camera is operating in Manual mode “M”, perform Manual White Balance when shooting under various types of lighting.

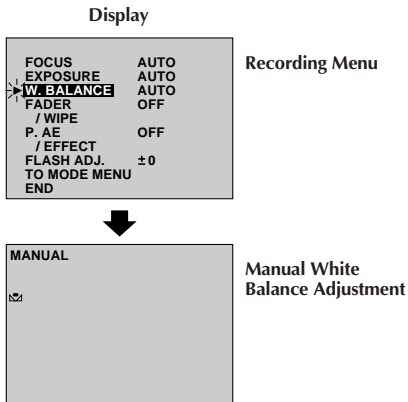
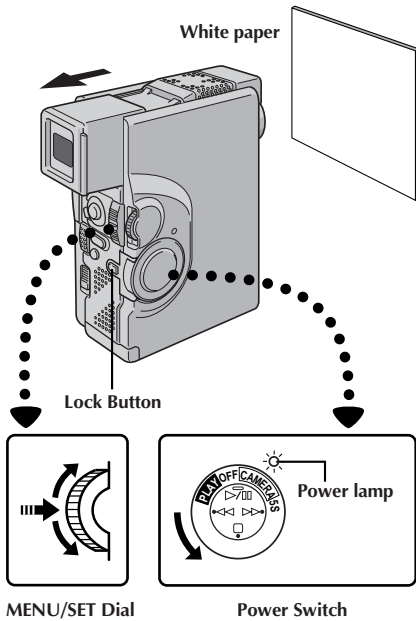

### 1 SELECT OPERATION MODE

Follow steps 1 through 5 of the white balance adjustment (☞ pg. 40), and select “MAN.”.

### 2 SET MANUAL WHITE BALANCE

Hold a sheet of plain white paper in front of the subject. Adjust zoom or position yourself so that the white paper fills the screen.

### 3 ENTER SETTING

Press MENU/SET until ☑ begins blinking.

• When the setting is completed, ☑ stops blinking.

### 4 EXIT MANUAL WHITE BALANCE ADJUSTMENT

Press MENU/SET. The indication “W.BAL.” changes to “MANUAL” and only the Manual White Balance indicator ☑ is displayed.

### To Change The Tint For Recording . . .

.... in step 2, substitute coloured paper for white. The white balance is adjusted based on the colour, changing the tint. Red paper — deeper green; blue paper — orange; yellow paper — deeper purple.

### NOTES:

- In step 2, it may be difficult to focus on the white paper in some circumstances. In such a case, adjust focus manually (☞ pg. 37).
- A subject can be shot under various types of lighting conditions indoors (natural, fluorescent, candlelight, etc.). Because the colour temperature is different depending on the light source, the tint of the subject will differ depending on the white balance settings. Use this function for a more natural result.
- Once you adjust white balance during Manual White Balance operation, the setting is retained even if the power is turned off or the battery removed.

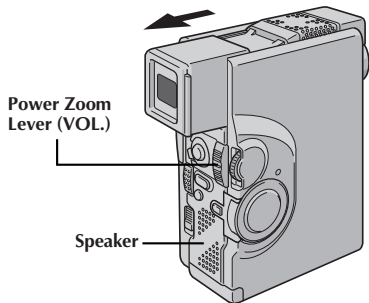
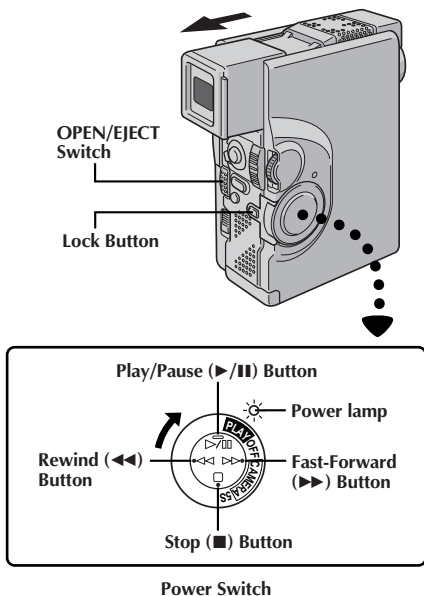

#### LCD monitor/Viewfinder Indication

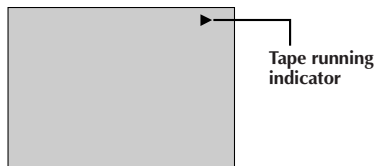

## 1 LOAD A CASSETTE

Slide **OPEN/EJECT** in the direction of the arrow, then swing the cassette cover open until it locks. The holder opens automatically. Insert a tape and press "PUSH HERE" to close the cassette holder.

## 2 SELECT OPERATION MODE

Set the Power Switch to "**PLAY**" while pressing down the Lock Button. The power lamp lights.

## 3 PLAY BACK

Press ▶/⏸. The playback picture appears.

## 4 STOP PLAYBACK

Press ■.

## Rewind or Fast-forward the tape

Press ◀◀ to rewind, or ▶▶ to fast-forward the tape during Stop mode.

## NOTES:

- If Stop mode continues for 5 minutes when the power supply is a battery pack, the camcorder shuts off automatically. To turn on again, set the Power Switch to "OFF", then to "**PLAY**".
- The playback picture can also be viewed in the viewfinder (with the viewfinder pulled out) or on a connected TV (☞ pg. 46, 47). Camcorder operation is the same as described in this section.
- You can also view the playback picture on the LCD monitor with it flipped over and retracted.
- LCD monitor/viewfinder indications:
  - When power is supplied from the battery pack: the "☐" battery pack remaining power indicator is displayed on the LCD monitor when it is turned on. When power is supplied through the DC cord: "☐" does not appear.
  - During Stop mode, none of the indications are displayed in the viewfinder.
- Copyguarded tapes cannot be played back. The screen displays a blue background.

## Speaker (or Headphones) Volume Control

You can adjust the speaker (or headphones connected to the headphones connector) volume by pushing the Power Zoom Lever.

## 1 ADJUST VOLUME

*If you want to turn up the volume . . .*

.... slide the Power Zoom Lever (VOL.) towards "+".

*If you want to turn down the volume . . .*

.... slide the Power Zoom Lever (VOL.) towards "-".

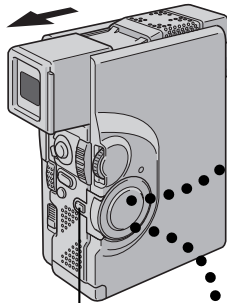
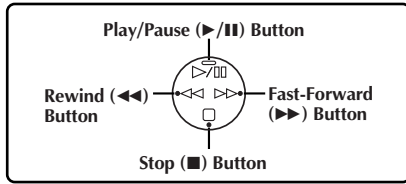

Lock Button

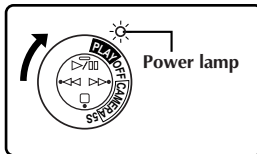

Power Switch

## FEATURE: Still Playback

### PURPOSE:

To pause during playback.

### OPERATION:

- 1) Press ▶/⏸ during playback.
- 2) To resume normal playback, press ▶/⏸ again.

### NOTES:

- If still playback continues for more than about 3 minutes, the camcorder's Stop mode is automatically engaged. After 5 minutes in the Stop mode, the camcorder's power is automatically turned off.
- When ▶/⏸ is pressed, the image may not pause immediately so that the camcorder can stabilise the still image. During this time, if PAUSE (⏸) on the remote control is pressed, Slow-Motion Playback will start. This is not a malfunction.

## FEATURE: Shuttle Search

### PURPOSE:

To allow high-speed search in either direction.

### OPERATION:

- 1) Press ▶▶ to forward or press ◀◀ to reverse during playback.
- 2) To resume normal playback, press ▶/⏸.

### NOTES:

- During playback, press and hold ◀◀ or ▶▶. The search continues as long as you hold the button. Once you release it, normal playback resumes.
- A slight mosaic effect appears on screen during Shuttle Search. This is not a malfunction.

## FEATURE: Slow-Motion Playback

Available only with the RM-V713U remote control (provided) (☞ pg. 54).

## FEATURE: Frame-By-Frame Playback

Available only with the RM-V713U remote control (provided) (☞ pg. 54).

## FEATURE: Playback Zoom

Available only with the RM-V713U remote control (provided) (☞ pg. 54).

## FEATURE: Playback Special Effects

Available only with the RM-V713U remote control (provided) (☞ pg. 55).

## Playback Menu

The Playback Menu allows you to set the following functions:

Playback Sound (32 kHz, 48 kHz), Synchro Comp, Indication, Display and Time Code. The following procedure applies to all except *Synchro Comp* (☞ pg. 60, 61).

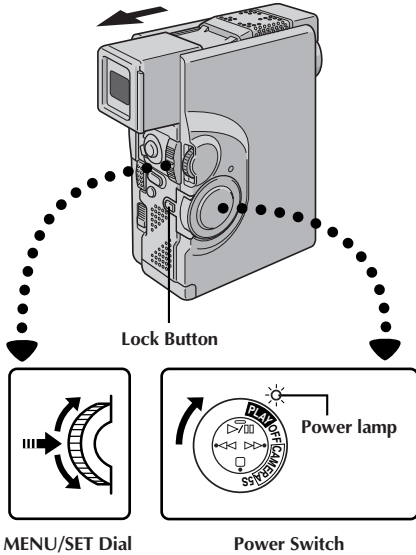

MENU/SET Dial

Power Switch

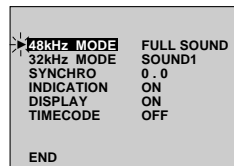
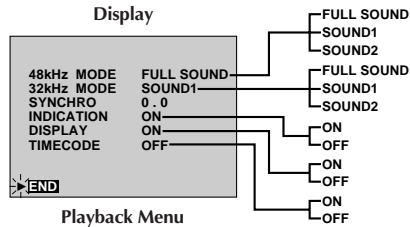

### 1 SELECT OPERATION MODE

Set the Power Switch to "PLAY" while pressing down the Lock Button. Pull out the viewfinder fully or open the LCD monitor fully.

### 2 ACCESS PLAYBACK MENU

Press MENU/SET. The Playback Menu appears.

### 3 SELECT FUNCTION

Move the highlight bar to the desired function by rotating MENU/SET. Press it to activate.

### 4 SET FUNCTION PARAMETERS

Rotate MENU/SET to cycle through the available settings for the selected function, and stop when the desired setting appears. Then press MENU/SET, and the highlight bar automatically moves to "END".

- To set parameters for other functions, repeat steps 3 and 4.

### 5 CLOSE MENU

Press MENU/SET again, and the menu disappears.

## Playback Sound

During playback, the camcorder detects the sound mode in which the recording was made, and plays the sound back. Select the type of sound to accompany your playback picture. (32 kHz is preset to "SOUND 1" and 48 kHz is preset to "FULL SOUND".)

Recording sound	Display	Output sound
32 kHz	FULL SOUND	Stereo sound
	SOUND 1	
	SOUND 2	
48 kHz	FULL SOUND	Stereo sound
	SOUND 1	"L" sound is output on both channels
	SOUND 2	"R" sound is output on both channels

When watching a tape recorded at 32 kHz, if you want to change the output sound, access the Playback Menu and, in step 3 on page 44, select "32 kHz MODE" and set it for "FULL SOUND", "SOUND 1" or "SOUND 2". When playing back a tape recorded at 48 kHz, set in the same manner.

### NOTES:

- You can also use the provided RM-V713U remote control's **AUDIO MONITOR** button to change the output sound (without having to access the Playback Menu). Make sure you point the remote control at the camcorder's remote sensor.
- During playback, the camcorder detects the sound mode in which the recording was made. This detection cannot be made during fast-forward or rewind. During playback the sound mode is displayed in the upper left corner.

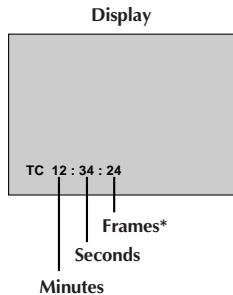

### TIME CODE (Displaying The Time Code During Playback)

You can display the Time Code on screen during playback. This is especially useful for editing. This function is preset to "OFF". To turn it on, select "TIME CODE" at the Playback Menu and change the setting (☞ pg. 44).

**ON**– The Time Code is displayed on the playback screen.

**OFF**– The Time Code does not appear.

### DISPLAY (Displaying the Date During Playback)

If the time has been set, the date is automatically recorded separately from the recorded video signal. You can display or remove the date anytime during playback. This function is preset to "ON". To turn it off, select "DISPLAY" at the Playback Menu and change the setting (☞ pg. 44).

**ON**– The date is displayed on the playback screen.

**OFF**– The date is not displayed.

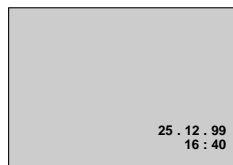

### INDICATION

You can make the Playback Sound, Time Code and Date indications disappear. This function overrides the "TIME CODE" and "DISPLAY" settings in the Playback Menu. The factory-preset is "ON". To turn it off, select "INDICATION" in the Playback Menu and change the setting (☞ pg. 44).

**OFF**– The Playback Sound, Time Code and Date indications do not appear on the Playback Screen.

**ON**– The Playback Sound, Time Code and Date indications are displayed according to how "TIME CODE" and "DISPLAY" are set in the Playback Menu.

### NOTE:

If "INDICATION" is set in the Mode Menu, "INDICATION" in the Playback Menu will also be set to the same setting (☞ pg. 28, 30).

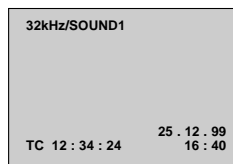

These are some basic types of connections. When making the connections, refer also to your VCR and TV instruction manuals.

## A. Connection to a TV or VCR equipped with a SCART connector compatible only with regular video signal

Use the provided Audio/Video (A/V) cable [mini-plug to RCA plug].

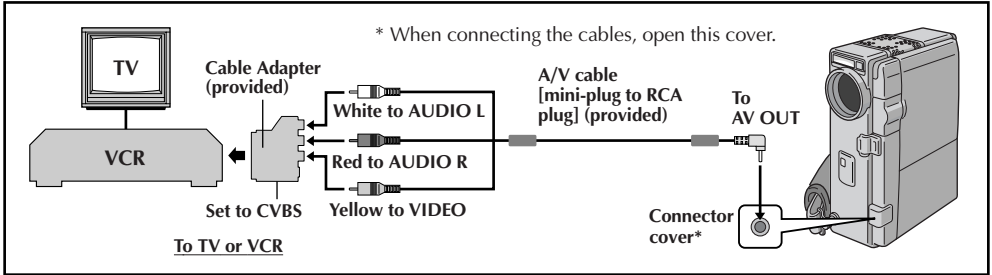

## B. Connection to a TV or VCR equipped with a SCART connector compatible with Y/C signal

Use the provided Docking Station, Audio/Video (A/V) cable [RCA plug to RCA plug] and S-Video cable.

### Docking Station Attachment

- ① Align the edge of the camcorder (A) with the edge of the Docking Station (B).
  - ② Align the direction stud and screw on the Docking Station with the stud hole and tripod mounting socket on the camcorder.
  - ③ Tighten the screw.
- When removing the camcorder, loosen the screw and detach the camcorder.

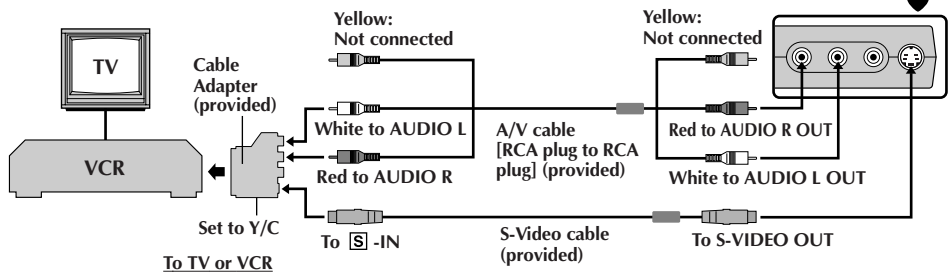
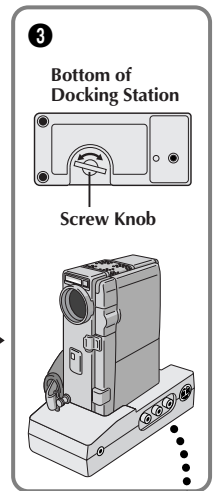
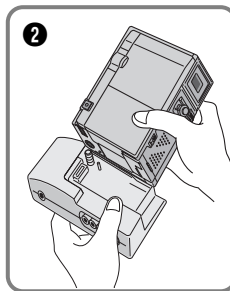
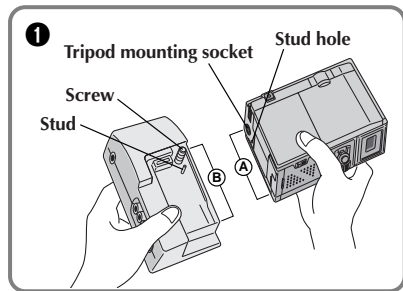

## C. Connection to a TV or VCR equipped with an S-VIDEO IN and/or A/V input (RCA type) connectors

Use the provided Docking Station, Audio/Video (A/V) cable [RCA plug to RCA plug] and S-Video cable.

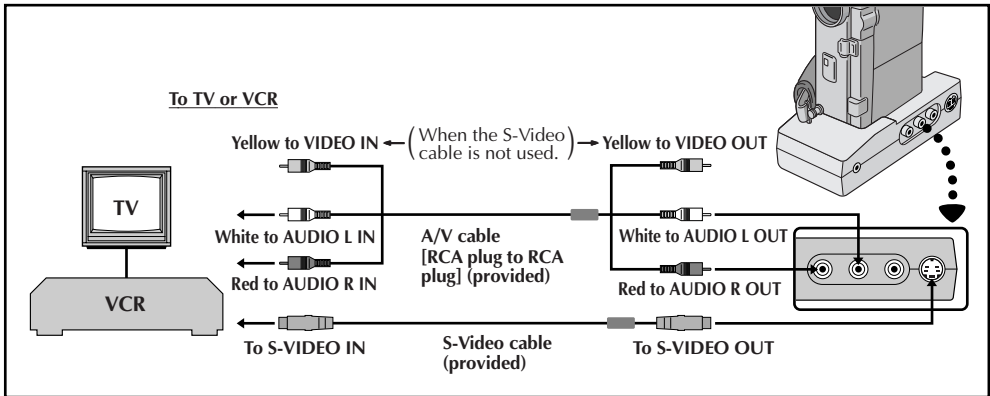

### 1 CONFIRM POWER-OFF STATUS

Make sure the camcorder's power is off.

### 2 CONNECT CAMCORDER TO TV OR VCR

Connect as shown in the illustration.

If Using A VCR . . . go to step 3.

If not . . . go to step 4.

### 3 CONNECT VCR OUTPUT TO TV INPUT

Refer to your VCR's instruction manual.

### 4 SUPPLY POWER

Turn on the camcorder, the VCR and the TV.

### 5 SELECT MODE

Set the VCR to its AUX input mode, and set the TV to its VIDEO mode.

**To choose whether or not the following displays appear on the connected TV . . .**

- Date/Time, Time Code  
 .... set to "ON" or "OFF" in the Playback Menu (☞ pg. 44).
- Playback Sound Mode Display  
 .... set the Operation Switch to "M", then set the Power Switch to the camera position ("CAMERA" or "5S") while pressing down the Lock Button. Press MENU/SET and set "ON SCREEN" in the Date/Time Menu (☞ pg. 28 - 30) to "ON" or "OFF". Then, set the Power Switch back to "PLAY".

## NOTES:

- It is recommended to use the AC Power Adapter/Charger as the power supply instead of the battery pack. (☞ pg. 7)
- Never connect any other Audio/Video cable than the provided Audio/Video cable (mini-plug to RCA plug) to the camcorder's AV OUT connector.
- When using the cables (except Audio/Video cable with mini-plug to RCA plug), make sure you connect the end of the cable with the core filter to the camcorder. The core filter reduces interference.
- To monitor the picture and sound from the camcorder without inserting a tape, set the camcorder's Power Switch to "CAMERA" or "5S", then set your TV to the appropriate input mode.
- Make sure you adjust the TV sound volume to its minimum level to avoid a sudden burst of sound when the camcorder is turned on.
- If you have a TV or speakers that are not specially shielded, do not place the speakers adjacent to the TV as interference will occur in the camcorder playback picture.
- To keep the camcorder's display from appearing on the TV screen during playback, set "INDICATION" to "OFF" in the Playback Menu (☞ pg. 44) and press DISPLAY on the remote control.
- While the Audio/Video cable is connected to the AV OUT connector, sound cannot be heard from the speaker.
- Set the video out select switch of the cable adapter as required:
  - Y/C : When connecting to a TV or VCR which accepts Y/C signals and uses an S-Video cable.
  - CVBS : When connecting to a TV or VCR which does not accept Y/C signals and uses an audio/video cable.

PC with DV connector-  
equipped capture board



PC

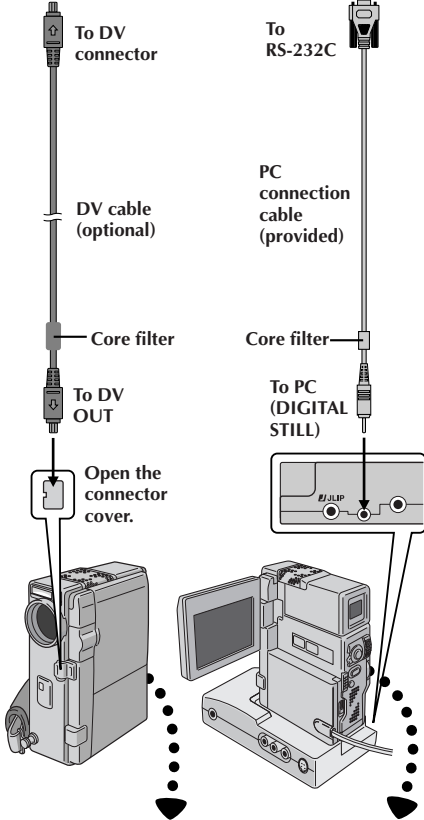

Lock Button

Power Switch

## Connection To A Personal Computer

This camcorder can transfer still images to a personal computer by using the provided software when connected as shown in the illustration. It is also possible to transfer still images to a personal computer with a DV connector-equipped capture board installed.

### 1 CONFIRM POWER-OFF STATUS

Make sure the camcorder and PC are turned off.

### 2 CONNECT TO PC

Connect the camcorder or Docking Station to your PC using the appropriate cable as shown in the illustration.

- To attach the camcorder to Docking Station, refer to "Docking Station Attachment" on pg. 46.

### 3 TURN ON POWER

Turn the camcorder's Power Switch to "PLAY" while pressing down the Lock Button and turn on the PC.

### NOTES:

- It is recommended to use the AC Power Adapter/Charger as the power supply instead of the battery pack (pg. 7).
- Never connect the PC connection cable and the DV cable simultaneously to the camcorder. Connect only the cable you wish to use to the camcorder.
- The date/time information cannot be captured into PC.
- Also refer to the instruction manuals of the provided Software and the DV connector-equipped capture board.
- Be sure to use a DV cable with the core filter.



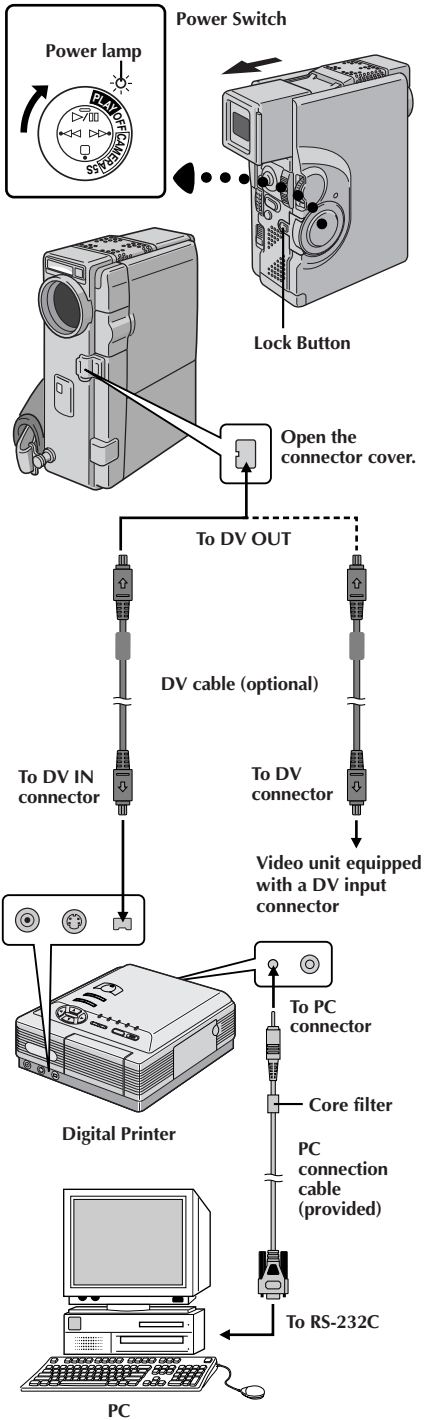

## Connection To A Video Unit Equipped With A DV Connector

Connection to the Digital Printer GV-DT3 (optional) allows you to print out the images or to transfer the captured image from the Digital Printer to a personal computer. It is also possible to copy recorded scenes from the camcorder onto another video unit equipped with a DV connector. This function is called Digital Dubbing (☞ pg. 51), which offers virtually no image or sound deterioration.

### 1 CONFIRM POWER-OFF STATUS

Make sure all the units are turned off.

### 2 CONNECT CAMCORDER TO PRINTER OR VIDEO UNIT EQUIPPED WITH DV INPUT CONNECTOR

Make connections to the device you want to connect to using the DV cable, as shown in the illustration.

### 3 CONNECT PRINTER TO PC (IF NECESSARY)

Connect the PC connection cable (provided) to the printer's PC connector and the PC's RS-232C connector.

### 4 TURN ON POWER

Turn the camcorder's Power Switch to "PLAY" while pressing down the Lock Button and turn on the other units.

## NOTES:

- It is recommended to use the AC Power Adapter/Charger as the power supply instead of the battery pack. (☞ pg. 7)
- When using the camcorder for dubbing, be sure to use it as a player. The camcorder's DV connector is only for output.
- If Still Playback, Slow-Motion Playback, Fast-Forward or Rewind is attempted with the camcorder connected to a video unit via the DV connector, the image will take on an effect similar to a coloured mosaic pattern or it will become black.
- Also refer to the instruction manuals of the connected units.
- Be sure to use a DV cable with the core filter.

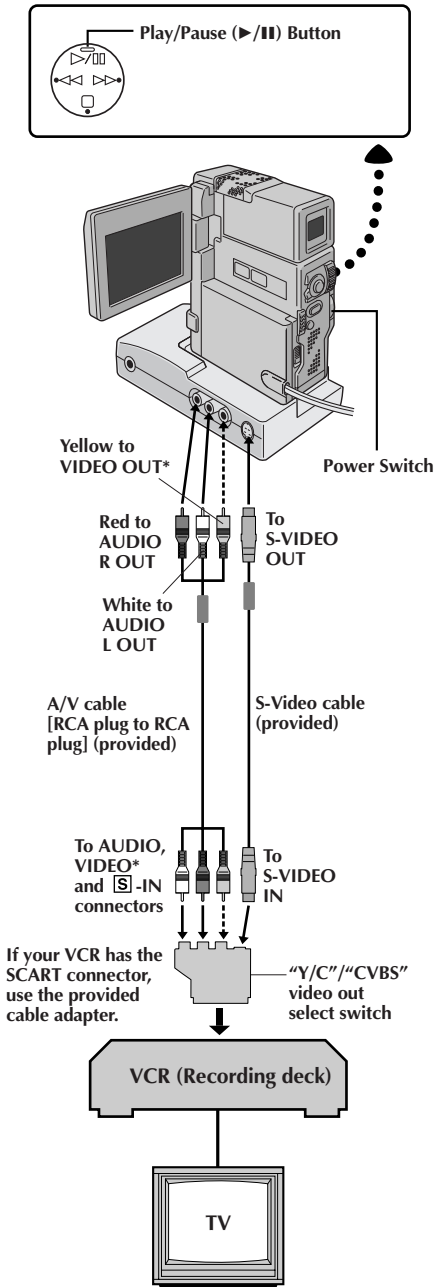

\*Connect when the S-Video cable is not used.

## Tape Dubbing

### 1 CONNECT EQUIPMENT

Following the illustration at left, connect the camcorder and the VCR. Also refer to pg. 46 and 47.

### 2 PREPARE FOR DUBBING

Set the camcorder's Power Switch to "PLAY", turn on the VCR's power, and insert the appropriate cassettes in the camcorder and the VCR.

### 3 SELECT VCR MODE

Engage the VCR's AUX and Record-Pause modes.

### 4 FIND EDIT-IN POINT

Engage the camcorder's Play mode to find a spot just before the edit-in point. Once it is reached, press ▶/⏸ on the camcorder.

### 5 START EDITING

Press ▶/⏸ on the camcorder and engage the VCR's Record mode.

### 6 STOP EDITING TEMPORARILY

Engage the VCR's Record-Pause mode and press ▶/⏸ on the camcorder.

### 7 EDIT MORE SEGMENTS

Repeat steps 4 through 6 for additional editing, then stop the VCR and camcorder when finished.

## NOTES:

- You can use the AV OUT connector on the camcorder for connection.
- You can use Playback Zoom (⏏ pg. 54) or Playback Special Effects (⏏ pg. 55) in step 5.
- Before you start dubbing, make sure that the indications do not appear on the connected TV. If they do appear during dubbing, they are being recorded onto the new tape.  
To clear the Playback Sound Mode Display, press **DISPLAY** on the RM-V713U remote control (provided).
- Select "DISPLAY" and "TIME CODE" from the Playback Menu (⏏ pg. 44) to show or hide the Date/Time and the Time Code on the recording.
- To keep all the camcorder's indications from appearing on the VCR, set "INDICATION" to "OFF" in the Playback Menu (⏏ pg. 44) and press **DISPLAY** on the remote control.
- Set the video out select switch of the cable adapter as required:  
Y/C : When connecting to a TV or VCR which accepts Y/C signals and uses an S-Video cable.  
CVBS : When connecting to a TV or VCR which does not accept Y/C signals and uses an audio/video cable.

## Digital Dubbing

It is also possible to copy recorded scenes from the camcorder onto other video unit equipped with a DV connector. Since a digital signal is sent, there is little if any image or sound deterioration.

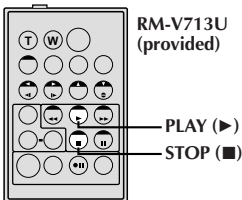
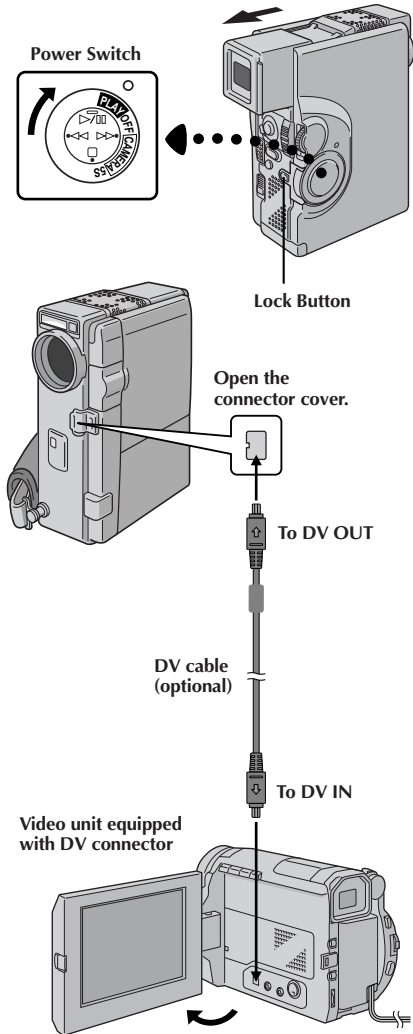

### 1 CONFIRM POWER-OFF STATUS

Make sure the camcorder's power is off.

### 2 MAKE CONNECTIONS

Connect the camcorder to your video unit equipped with a DV connector using the DV cable (optional) as shown in the illustration.

### 3 START PLAYBACK

Press ▶ to play back the source tape.

### 4 START RECORDING

While watching the playback on the monitor, engage the DV connector-equipped video unit's record mode from the spot on the source tape you want to begin recording.

## NOTES:

- It is recommended to use the AC Power Adapter/Charger as the power supply instead of the battery pack (☞ pg. 7).
- When using the camcorder for dubbing, be sure to use it as a player. The camcorder's DV connector is only for output.
- If a blank portion or disturbed image is played back on the player during dubbing, the dubbing may stop so that an unusual image is not dubbed.
- Even though the DV cable is connected correctly, sometimes the image may not appear in step 3. If the above occurs, turn off power and make connections again.
- If "Playback Zoom" (☞ pg. 54), "Playback Special Effects" (☞ pg. 55) or "Snapshot" is attempted during playback, only the original playback image recorded on the tape is output from the DV OUT connector.
- Be sure to use a DV cable with the core filter.

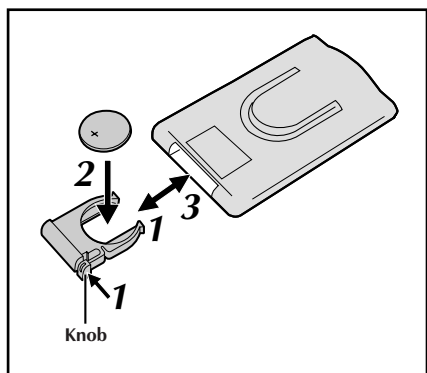

The Full-Function Remote Control Unit can operate this camcorder from a distance as well as the basic operations (Playback, Stop, Pause, Fast-Forward and Rewind) of your VCR. This remote control unit makes additional playback functions possible.

## Installing The Battery

The remote control uses one lithium battery (CR2025).

- 1 PULL OUT BATTERY HOLDER**  
Pull out the battery holder while pressing the knob as shown.
- 2 INSERT BATTERY IN HOLDER**  
Insert the battery in the holder, and be sure to have the "+" mark visible.
- 3 RE-INSERT HOLDER**  
Slide the holder back in until you hear a click.
  - Read the caution concerning lithium batteries (☞ pg. 2).

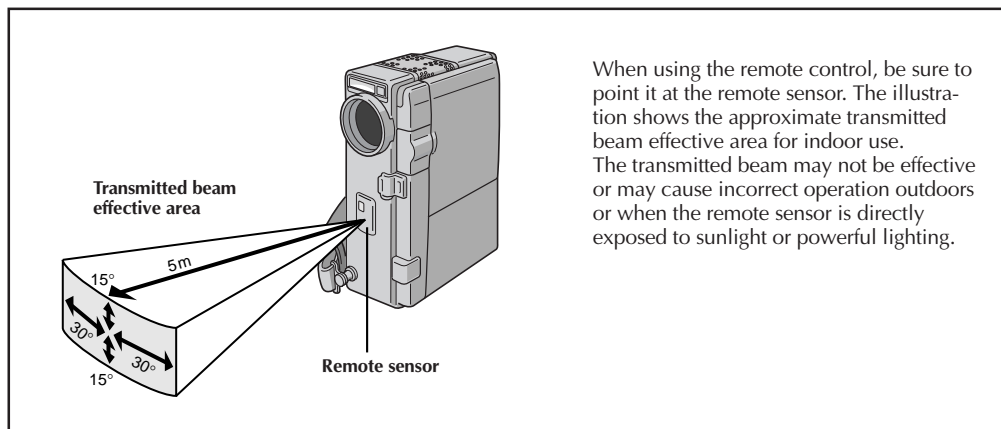

When using the remote control, be sure to point it at the remote sensor. The illustration shows the approximate transmitted beam effective area for indoor use. The transmitted beam may not be effective or may cause incorrect operation outdoors or when the remote sensor is directly exposed to sunlight or powerful lighting.

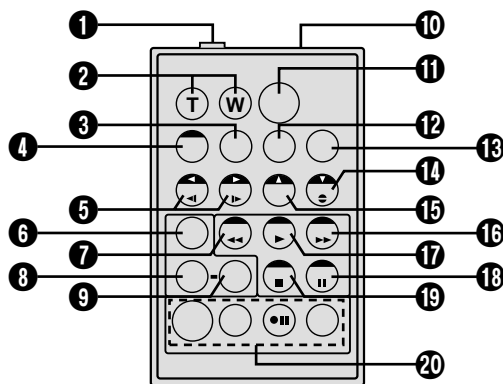

RM-V713U (provided)

Buttons	Functions	
	With the camcorder's Power Switch set to the camera position ("CAMERA" or "5S").	With the camcorder's Power Switch set to "PLAY".
① PAUSE IN Connector	—	☞ pg. 57
② Zoom (T/W) Buttons	Zoom in/out (☞ pg. 18)	Zoom in/out (☞ pg. 54)
③ DISPLAY Button	—	☞ pg. 50
④ SHIFT Button	—	☞ pg. 54
⑤ SLOW Rewind/Forward Buttons Left/Right Buttons	— —	☞ pg. 54 ☞ pg. 54
⑥ FADE/WIPE Button	—	☞ pg. 57
⑦ REW Button	—	Rewind, Reverse Shuttle Search (☞ pg. 42, 43)
⑧ EFFECT Button	—	☞ pg. 55
⑨ EFFECT ON/OFF Button	—	☞ pg. 55
⑩ Infrared beam transmitting window	Transmits the beam signal.	
⑪ START/STOP Button	Functions same as START/STOP on the camcorder.	
⑫ AUDIO MONITOR Button	—	☞ pg. 45
⑬ MBR SET Button	—	☞ pg. 56
⑭ Down Button A.DUB Button	— —	☞ pg. 54 ☞ pg. 62
⑮ Up Button	—	☞ pg. 54
⑯ FF Button	—	Fast-Forward, Forward Shuttle Search (☞ pg. 42, 43)
⑰ PLAY Button	—	Playback start (☞ pg. 42)
⑱ PAUSE Button	—	Pause (☞ pg. 43)
⑲ STOP Button	—	Stop (☞ pg. 42)
⑳ R.A.EDIT Buttons	—	☞ pg. 56 – 61

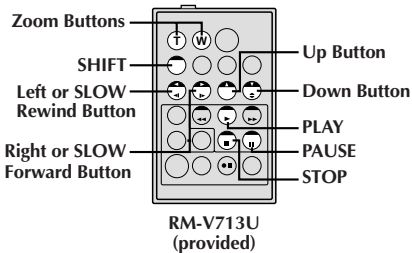
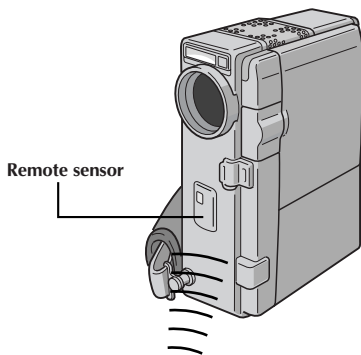
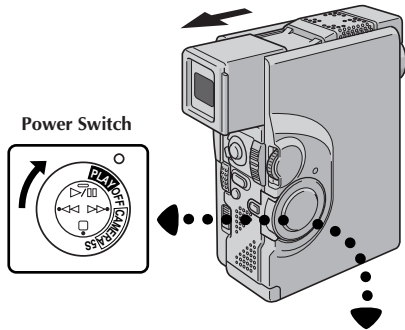

Normal playback



Press T



To move image, press (Right) while keeping SHIFT held down.

## FEATURE: Slow-Motion Playback

### PURPOSE:

To allow slow-speed search in either direction.

### OPERATION:

- 1) To change from normal to Slow-Motion Playback, press **PAUSE** (■) at the point where you want to start playback in slow motion.
  - 2) Press **SLOW** (◀ or ▶). After playing back for approx. 1 minute in Slow Rewind or approx. 2 minutes in Slow Forward, normal playback resumes.
- To stop Slow-Motion Playback in progress, press **PLAY** (▶).

### NOTES:

- During Slow-Motion Playback, due to digital image processing, the picture may take on a mosaic effect.
- After **SLOW** (◀ or ▶) is pressed, the still image may be displayed for a few seconds, then the screen may become blue back for a few seconds. This is not a malfunction.
- There may be a small margin between the slow-motion playback start point you chose and the start point at which the camcorder actually begins playback in slow motion.
- During Slow-Motion Playback, there will be disturbances in video and the picture may seem unstable, especially with steady images. This is not a malfunction.
- During Slow-Motion Playback, press **PAUSE** (■) to pause playback.

## FEATURE: Frame-By-Frame Playback

### PURPOSE:

To allow frame-by-frame search.

### OPERATION:

- 1) To change from normal to Frame-By-Frame Playback, press **PAUSE** (■) at the point where you want to start Frame-By-Frame Playback.
- 2) Press **PAUSE** (■) repeatedly. Each time it is pressed, the frame is played back.

## FEATURE: Playback Zoom

### PURPOSE:

To magnify the recorded image up to 10X at any time during playback.

### OPERATION:

- 1) Press **PLAY** (▶) to find the scene of interest.
  - 2) Press the Zoom Buttons (T/W) on the remote control. Make sure the remote control is pointed at the camcorder's remote sensor. Pressing **T** zooms in.
  - 3) You can move the image on screen around to find a particular portion of the picture. While holding down **SHIFT**, press (Left), (Right), (Up) and (Down).
- To end zoom, press and hold **W** until magnification returns to normal. Or, press **STOP** (■) and then press **PLAY** (▶).

### NOTES:

- Zoom can also be used during slow-motion and still playback.
- During digital image processing, the quality of the image may suffer.

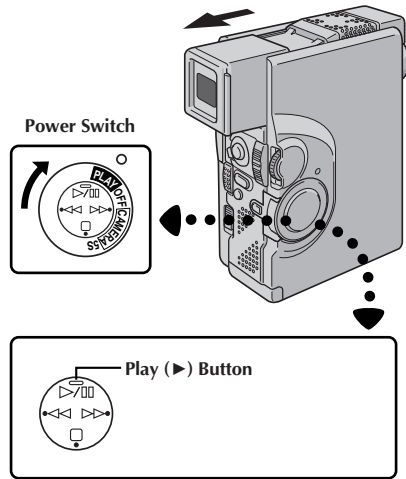

PLAYBACK EFFECT	
OFF	
1	CLASSIC FILM
2	MONOTONE
3	SEPIA
4	STROBE
5	VIDEO ECHO

#### PLAYBACK EFFECT Select Menu

## FEATURE: Playback Special Effects

### PURPOSE:

To allow you to add creative effects to the playback image. You can use any one of the 5 effects.

### OPERATION:

- 1) To start playback, press **PLAY** (▶).
- 2) Point the remote control at the camcorder's remote sensor and press **EFFECT**. The **PLAYBACK EFFECT Select Menu** appears.
- 3) Move the highlight bar to the desired effect by pressing **EFFECT**. The selected function is activated and after 2 seconds the menu disappears.
  - To deactivate the selected effect, press **EFFECT ON/OFF** on the remote control. Pressing it again re-activates the selected effect.
  - To change the selected effect, repeat from step 2 of the above "OPERATION".

### NOTES:

- When some Playback Special Effects are used, the Multi-Analyser 4 and Multi-Analyser 9 Snapshot modes (pg. 24) are not available.
- The effects that can be used during playback are Classic Film, Monotone, Sepia, Strobe and Video Echo. The effects work the same in playback as they did in recording. Refer to page 35 for more information.

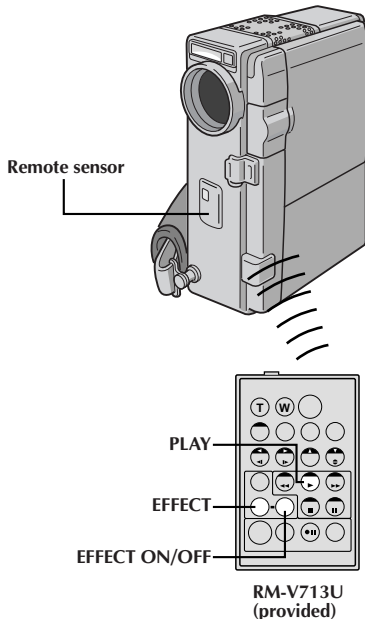

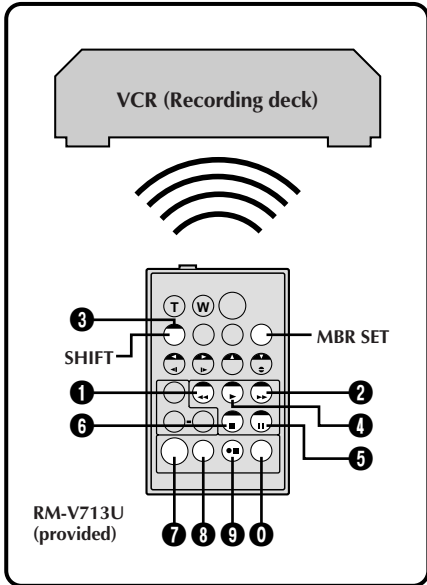

## VCR CODE LIST

VCR BRAND NAME	BUTTONS (A) (B)	VCR BRAND NAME	BUTTONS (A) (B)
AKAI	6 2 6 4 7 7	PHILIPS	1 9 9 5 1 1 9 4 9 1 9 6 1 2 3 3 7 2
BLAUPUNKT	1 3	SANYO	3 6 3 5
FERGUSON	9 7 9 8 3 2	SELECO, REX	9 1 9 6
GRUNDIG	1 4 3 4	SHARP	1 5 1 0
HITACHI	6 6 6 3	SONY	6 5 6 0 3 9 3 1
JVC A B C	9 1 9 6 9 3	THOMSON, TELEFUNKEN, SABA, NORDMENDE	9 1 9 6 9 7 3 2
MITSUBISHI	6 7 6 8	TOSHIBA	6 9 6 1
NEC	3 7 3 8		
PANASONIC	1 3 1 7 1 1 9 4 1 8		

## Random Assemble Editing [R.A.Edit]

Create edited videos easily using your camcorder as the source player. You can select up to 8 "cuts" for automatic editing, in any order you like. R.A.Edit is more easily performed when the RM-V713U MBR (Multi-Brand Remote, pg. 52) is set to operate with your brand of VCR (see VCR CODE LIST), but can also be performed by operating the VCR manually.

Before operation, make sure the lithium battery is installed in the remote control RM-V713U ( pg. 52).

## SET REMOTE/VCR CODE

## 1 SET REMOTE TO OPERATE VCR

Turn off the power to the VCR and point the remote towards the VCR's infrared sensor. Then, referring to the VCR CODE LIST on the left, press and hold **MBR SET**, and press button (A) and then (B).

- The code is automatically set once you release **MBR SET**, and the VCR's power comes on.

## 2 OPERATE VCR

Make sure the VCR's power is on. Then, while holding **SHIFT**, press the button on the remote for the desired function. The functions the remote can control are PLAY, STOP, PAUSE, FF, REW and VCR REC STBY (you do not need to press **SHIFT** for this one).

*You are now ready to try Random Assemble Editing.*

## IMPORTANT

Although the MBR is compatible with JVC VCRs and those of many other makers, it may not work with yours or may offer limited functions.

## NOTES:

- If the VCR's power does not come on in step 1, try another code from the VCR CODE LIST.
- Some brands of VCR do not come on automatically. In this case, turn the power on manually and try step 2.
- If the remote control is not able to control the VCR, use the controls on the VCR.
- When the remote control's battery runs out, the VCR brand you have set will be erased. In that case, replace the old battery with a new one to reset the VCR brand.



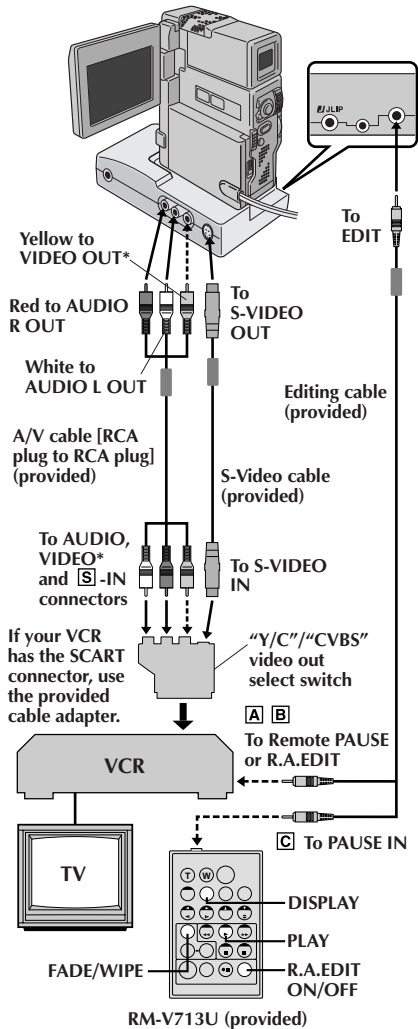

\*Connect when the S-Video cable is not used.

## NOTES:

- You can use the AV OUT connector on the camcorder for connection.
- Before Random Assemble Editing, make sure the indications do not appear on the TV monitor. If they appear during Random Assemble Editing, they will be recorded onto the new tape. To clear the Playback Sound Mode Display, press **DISPLAY** on the remote control. Select "DISPLAY" and "TIME CODE" from the Playback Menu (☞ pg. 44) to show or hide the Date/Time and the Time Code on the recording. To show or hide all indications except for the Random Assemble Editing Menu, set "INDICATION" to "OFF" in the Playback Menu (☞ pg. 44) and press **DISPLAY** on the remote control. When Random Assemble Editing starts, its indications disappear and are not recorded on the new tape.
- When editing on a VCR equipped with DV input connector, the DV cable can be connected instead of the S-Video cable and Audio/Video cable.
- Set the video out select switch of the cable adapter as required:  
Y/C: When connecting to a TV or VCR which accepts Y/C signals and uses an S-Video cable.  
CVBS: When connecting to a TV or VCR which does not accept Y/C signals and uses an audio/video cable.

## MAKE CONNECTIONS

Also refer to pg. 46, 47 and 49.

### 1 CONNECT TO . . .

**A JVC VCR EQUIPPED WITH REMOTE PAUSE TERMINAL**

Connect the editing cable to the Remote PAUSE terminal.

**B JVC VCR NOT EQUIPPED WITH REMOTE PAUSE TERMINAL BUT EQUIPPED WITH R.A.EDIT CONNECTOR**

Connect the editing cable to the R.A.EDIT connector.

**C VCR OTHER THAN TYPE A OR B**

Connect the editing cable to the RM-V713U's PAUSE IN connector.

### 2 PREPARE CAMCORDER

Insert a recorded tape and set the Power Switch to "PLAY" while pressing down the Lock Button.

### 3 PREPARE VCR

Turn the power on, insert a recordable tape and engage the AUX mode (refer to VCR's instructions).

## SELECT SCENES

### 4 START SOURCE PLAYBACK

Press **PLAY** (▶) and then press **R.A.EDIT ON/OFF** on the remote control. Make sure to point the remote control at the camcorder's remote sensor.

- The Random Assemble Editing Menu appears.

### 5 EXECUTE FADE/WIPE IN (IF NECESSARY)

Press **FADE/WIPE** on the remote control.

- Cycle through the effects by pressing repeatedly, and stop when the one you want is displayed.
- You cannot use a Picture Wipe/Dissolve at the beginning of Programme 1.

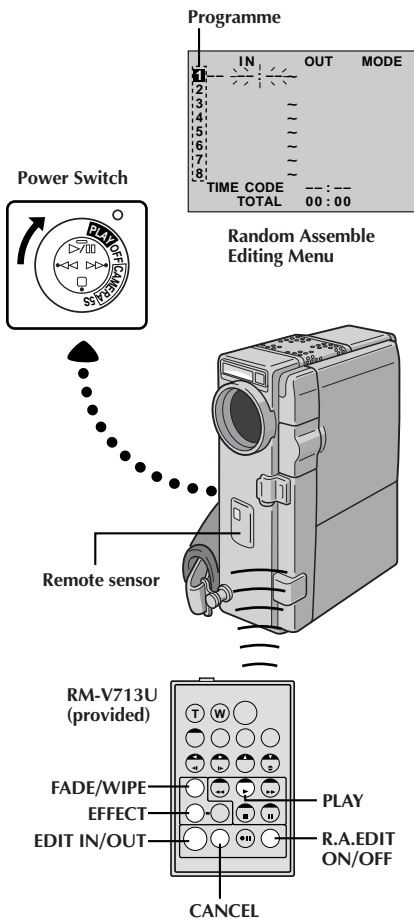

## SELECT SCENES (cont.)

**6 SET EDIT-IN POINT**

At the beginning of the scene, press **EDIT IN/OUT** on the remote control. The Edit-In position appears on the Random Assemble Editing Menu.

**7 SET EDIT-OUT POINT**

At the end of the scene, press **EDIT IN/OUT**. The Edit-Out position appears on the Random Assemble Editing Menu.

**8 USE FADE/WIPE ON SCENE TRANSITION (IF NECESSARY)**

Press **FADE/WIPE**.

- Cycle through the effects by pressing repeatedly, and stop when the one you want is displayed.
- If you select a Fade/Wipe effect for an Edit-Out point, the effect is automatically applied to the following Edit-In point.
- You cannot use a Picture Wipe/Dissolve at the end of the last scene.
- When you use Fade/Wipe effects, that time is included in the total time (this does not apply to Picture Wipe/Dissolve).

**9 USE PLAYBACK SPECIAL EFFECTS (IF NECESSARY, see pg. 55)**

Press **EFFECT**.

**10 REGISTER ADDITIONAL SCENES**

Repeat steps 6 through 9.

- To change previously registered points, press **CANCEL** on the remote control. The registered points disappear, one at a time, from the most recently registered point.
- If you are not using Fade/Wipe or Programme AE with special effects, repeat steps 6 and 7 only.

**NOTES:**

- When the source tape has more than 2 identical time codes (see pg. 19), the camcorder may not find the Edit-In point you chose and a malfunction may occur.
- When choosing a scene, set Edit-In and Edit-Out points so that there is a relatively large difference between them.
- If the search time for an in-point exceeds 5 minutes, the recording deck's Record-Standby mode will be cancelled and editing will not take place.
- If there are blank portions before or after the Edit-In and Edit-Out points, a blue-backed screen may be included in the edited version.
- Since time codes register time only as accurately as seconds, the time code total time may not match the total programme time exactly.
- Turning off the camcorder's power erases all registered Edit-In and Edit-Out points.
- If you select Sepia or Monotone mode from Programme AE with special effects, you cannot use the Dissolve or Black & White Fader. In this case the Dissolve or Black & White indicator begins blinking. Once the next Edit-In point is registered, the effect is turned off. To combine these effects, use Sepia or Monotone during recording, then use Dissolve or Black & White Fader during Random Assemble Editing.
- It is not possible to use Fade/Wipe effects and Programme AE with special effects during Random Assemble Editing using a DV cable.

## AUTOMATIC EDITING TO VCR

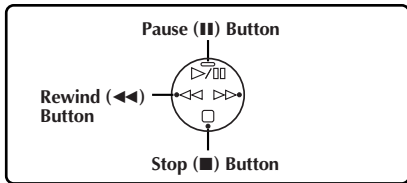
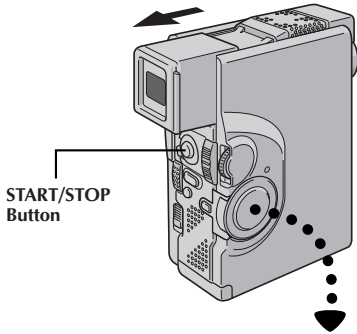

	IN	OUT	MODE
1	00:25	02:05	P
2	07:18	08:31	B/W
3	03:33	05:53	
4	09:30	13:15	
5	15:55	16:20	
6			
7			
8			
	TIME CODE	16:30	
	TOTAL	9:39	

Random Assemble Editing Menu

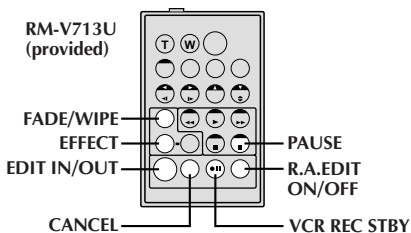
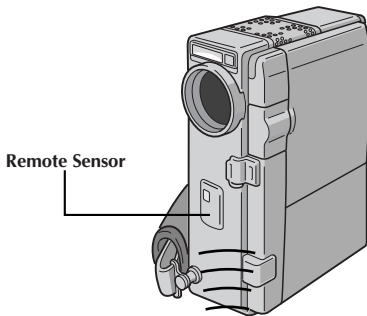
**11 PREPARE SOURCE TAPE**

Rewind the tape in the camcorder to the beginning of the scene you want to edit and press **PAUSE (II)**.

**12 ENGAGE VCR'S RECORD-PAUSE MODE**

Point the remote control towards the VCR's remote sensor and press **VCR REC STBY (● II)**, or manually engage the VCR's Record-Pause mode.

**13 START EDITING**

Press **START/STOP** on the camcorder. Editing proceeds as programmed, right through to the end of the last registered scene.

- Pressing **START/STOP** on the remote control does not start editing.
- When dubbing is complete, the camcorder enters the Pause mode, and the recording deck enters its Record-Standby mode.
- If you do not register an Edit-Out point, the tape will be dubbed all the way to the end automatically.

**14 STOP EDITING**

Engage the Stop modes for the camcorder and the VCR.

To make the R.A.Edit counter display disappear, press **R.A.EDIT ON/OFF** on the remote control.

**NOTES:**

- Pressing **R.A.EDIT ON/OFF** on the remote control clears all settings registered during Random Assemble Editing.
- When the editing cable is connected to the Pause terminal during dubbing, make sure the remote control is pointed at the VCR's sensor, and that the path between the two is unobstructed.
- Random Assemble Editing may not function properly when using a tape including several duplicated Time Codes (see pg. 19).

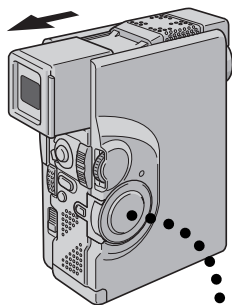

Programme 1

	IN	OUT	MODE
1			
2			
3			
4			
5			
6			
7			
8			
TIME CODE			
TOTAL			00:00

Random Assemble Editing Menu

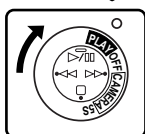

Power Switch

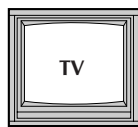

TV

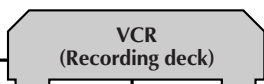
VCR  
(Recording deck)

Remote sensor

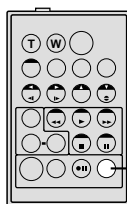
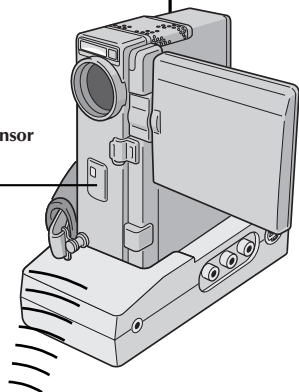
RM-V713U  
(provided)R.A.EDIT  
ON/OFF

## For More Accurate Editing

Some VCRs make the transition from Record-Standby to Record mode faster than others. Even if you begin editing for the camcorder and the VCR at exactly the same time, you may lose scenes you wanted, or find that you have recorded scenes you did not want. For a cleanly edited tape, confirm and adjust the timing of the camcorder against your VCR.

## DIAGNOSING VCR'S AGAINST CAMCORDER TIMING

1

### PREPARE FOR R.A.EDIT

Play back the tape in the camcorder, then point the remote control at the camcorder's remote sensor and press **R.A.EDIT ON/OFF**.

- "Random Assemble Editing Menu" appears.

2

### CHOOSE A SCENE

Perform Random Assemble Editing on Programme 1 only. In order to check VCR and camcorder timing, select the beginning of a scene transition as your Edit-In point.

3

### PLAY BACK DUBBED SCENE

- If any images from the scene prior to the transition you chose for your Edit-In point were recorded, that means your VCR moves quickly from Record-Pause to Record mode.
- If the scene you tried to dub starts in progress, the VCR is slow to start recording.

## ADJUSTMENT OF VCR'S AGAINST CAMCORDER TIMING

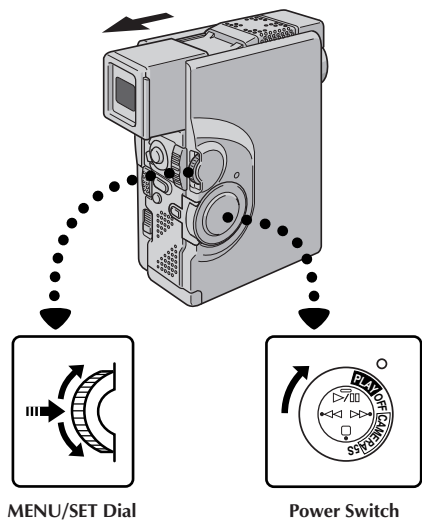

MENU/SET Dial

Power Switch

Display

48kHz MODE	FULL SOUND
32kHz MODE	SOUND1
SYNCHRO	0.0
INDICATION	ON
DISPLAY	ON
TIMECODE	OFF
END	

Playback Menu

48kHz MODE	FULL SOUND
32kHz MODE	SOUND1
▶ SYNCHRO	0.0
INDICATION	ON
DISPLAY	ON
TIMECODE	OFF
END	

### 4 ACCESS PLAYBACK MENU

Point the remote control at the camcorder's remote sensor and press **R.A.EDIT ON/OFF** to make the Random Assemble Editing menu disappear, then press **MENU/SET**. The Playback Menu appears.

### 5 SELECT FUNCTION

Move the highlight bar to "SYNCHRO" by rotating **MENU/SET**, then press it. The value for "SYNCHRO" is highlighted.

### 6 INPUT CORRECTION DATA

Based on the diagnostics performed (see pg. 60), you can now increase the VCR's speed by rotating **MENU/SET** upward. You can also slow down the VCR's speed by rotating **MENU/SET** downward. The adjustment range is from -1.3 to +1.3 seconds, in 0.1-second increments.

### 7 CLOSE MENU

Press **MENU/SET** twice.

- Now perform Random Assemble Editing beginning with step 4 on page 57.

## NOTES:

- Before performing actual Random Assemble Editing, do a few Random Assemble Editing trial runs to check whether the value you have input is appropriate or not, and make adjustments accordingly.
- Depending on the recorder, there may be situations where the timing difference cannot be fully corrected.

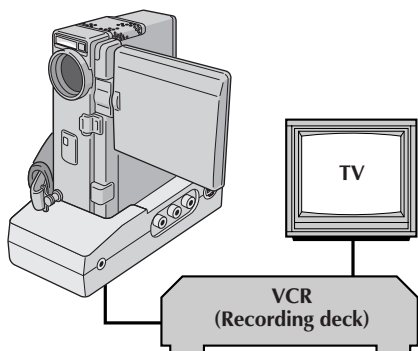

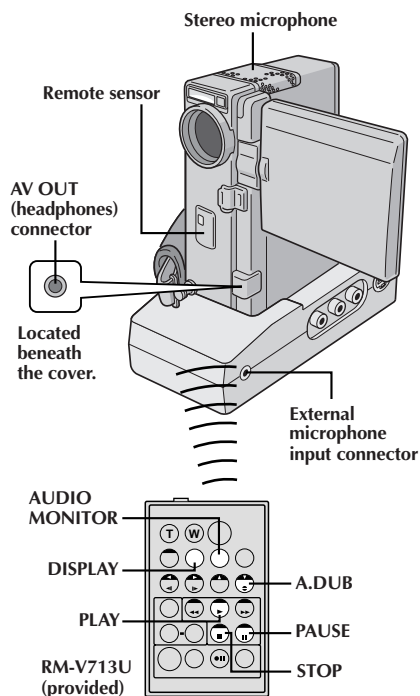
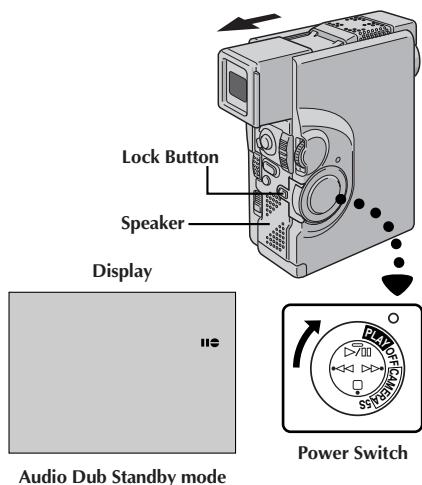

## Audio Dubbing

The audio track can be customized only when recorded on the 32 kHz mode (☞ pg. 30).

### NOTES:

- Audio Dubbing is not possible on a tape recorded at 48 kHz, on a tape recorded in the LP mode or on a blank portion of a tape.
- To perform Audio Dubbing while watching in the television, make connections (☞ pg. 46).

### 1 FIND EDIT-IN POINT

Play back the tape to locate the point where editing will start, then press PAUSE (II).

### 2 ENGAGE AUDIO DUB STANDBY

While holding A.DUB (⊖) on the remote control, press PAUSE (II). "II" appears.

### 3 BEGIN DUBBING

Press PLAY (▶), then begin "narrating".

- Speak into the microphone.

### 4 PAUSE DURING DUBBING

Press PAUSE (II).

### 5 STOP DUBBING

Press STOP (■).

### NOTES:





- Audio dubbing is also possible using an optional microphone.
- While an optional microphone is connected, the built-in microphone is disabled.
- When editing onto a tape that was recorded at 32 kHz, the old and new soundtracks are recorded separately.
- To select the desired sound for playback, press **AUDIO MONITOR** on the remote control.
- If you dub onto a blank space on the tape, the sound may be disrupted. Make sure you only edit recorded areas.
- If feedback or howling occurs during TV Playback, move the camcorder's microphone away from the TV, or turn down the TV's volume.
- Sound is not heard from the speaker during Audio Dubbing. To hear sound, connect optional headphones to the AV OUT (headphones) connector.
- If you change from 32 kHz to 48 kHz in mid-recording and then use the tape for Audio Dubbing, it is not effective from the point where 48 kHz recording began.
- During Audio Dubbing, when the tape moves to scenes recorded in the LP mode, scenes recorded at 48 kHz or a blank portion, Audio Dubbing stops and "ERROR! REFER MANUAL" appears.

Recording sound	Display	Output sound
32 kHz	FULL SOUND	Original and new tracks are combined and output in stereo.
	SOUND 2	New track is output on both "L" and "R" channels in stereo.
	SOUND 1	Original track is output on both "L" and "R" channels in stereo.

If, after following the steps in the chart below, the problem still exists, please consult your nearest JVC dealer.

The camcorder is a microcomputer-controlled device. External noise and interference (from a TV, a radio, etc.) might prevent it from functioning properly. In such cases, first disconnect its power supply unit (battery pack, AC Power Adapter/Battery Charger, etc.) and wait a few minutes; and then re-connect it and proceed as usual from the beginning.

SYMPTOM	POSSIBLE CAUSES	CORRECTIVE ACTION
1. No power is supplied.	1. <ul style="list-style-type: none"> <li>• The power is not connected properly.</li> <li>• The battery is dead.</li> <li>• The LCD monitor is not open fully or the viewfinder is not pulled out when recording.</li> </ul>	1. <ul style="list-style-type: none"> <li>• Connect the AC Power Adapter/Charger securely (☞ pg. 7).</li> <li>• Replace the dead battery with a fully charged one (☞ pg. 6, 7).</li> <li>• Open the LCD monitor fully or pull out the viewfinder. The LCD monitor turns on/off when it is opened/closed at approx. 90° while the Power Switch is set to any position except "OFF" if the viewfinder is not fully pulled out.</li> </ul>
2. "SET DATE/TIME!" appears.	2. <ul style="list-style-type: none"> <li>• The built-in clock's rechargeable lithium battery is discharged.</li> <li>• The previously set date/time is erased.</li> </ul>	2. <ul style="list-style-type: none"> <li>• Connect the camcorder to an AC outlet using the AC Power Adapter/Charger for over 24 hours to charge the clock's lithium battery (☞ pg. 8).</li> </ul>
3. Recording cannot be performed.	3. <ul style="list-style-type: none"> <li>• The tape's erase protection switch is set to "SAVE".</li> <li>• The Power Switch is set to "PLAY".</li> <li>• "TAPE END" appears.</li> <li>• The cassette's cover is open.</li> </ul>	3. <ul style="list-style-type: none"> <li>• Set the tape's erase protection switch to "REC" (☞ pg. 9).</li> <li>• Set the Power Switch to any position except "PLAY" or "OFF" (☞ pg. 13).</li> <li>• Replace with new cassette (☞ pg. 9).</li> <li>• Close the cassette's cover.</li> </ul>
4. There is no picture.	4. <ul style="list-style-type: none"> <li>• The camcorder is not getting power, or some other malfunction exists.</li> </ul>	4. <ul style="list-style-type: none"> <li>• Turn the camcorder's power off and on again (☞ pg. 14).</li> </ul>
5. Some functions are not available using MENU/SET.	5. <ul style="list-style-type: none"> <li>• The Operation Switch is set to "A".</li> </ul>	5. <ul style="list-style-type: none"> <li>• Set the Operation Switch to "M" (☞ pg. 13).</li> </ul>
6. The focus does not adjust automatically.	6. <ul style="list-style-type: none"> <li>• Focus is set to "MANUAL".</li> <li>• The recording was done in a dark place, or the contrast was low.</li> <li>• The lens is dirty or covered with condensation.</li> </ul>	6. <ul style="list-style-type: none"> <li>• Set Focus to "AUTO" (☞ pg. 37).</li> <li>• Clean the lens and check the focus again (☞ pg. 69).</li> </ul>
7. The cassette will not load properly.	7. <ul style="list-style-type: none"> <li>• The cassette is in the wrong position.</li> <li>• The battery's charge is low.</li> </ul>	7. <ul style="list-style-type: none"> <li>• Set it in the right position (☞ pg. 9).</li> <li>• Install a fully charged battery (☞ pg. 6, 7).</li> </ul>
8. In the 5-Second mode, recording ends before 5 seconds have elapsed.	8. <ul style="list-style-type: none"> <li>• The 5-Second mode in the System Menu is set to "ANIM.".</li> </ul>	8. <ul style="list-style-type: none"> <li>• Select "5S" or "5SD" in the System Menu (☞ pg. 28, 30).</li> </ul>

SYMPTOM	POSSIBLE CAUSES	CORRECTIVE ACTION
9. Snapshot mode cannot be used.	9. • The Squeeze mode is selected.	9. • Disengage the Squeeze mode (☞ pg. 29).
10. Although Snapshot is attempted, flash does not take place.	10. • The subject is too bright with the flash set to "AUTO" or "AUTO  ". • If  blinks, the flash is being charged. • Multi-Analyser 4 or Multi-Analyser 9 is selected. • The camcorder is in the Record mode.	10. • Set "FLASH" to "ON" in the Mode Menu (☞ pg. 26). • It can take up to 10 seconds to charge the flash. • Disengage Multi-Analyser 4 or Multi-Analyser 9 (☞ pg. 24). • Set the camcorder in the Record-Standby mode (☞ pg. 26).
11. Although Snapshot is taken with the flash, Red-Eye Reduction does not take place.	11. • The subject does not look straight toward the flash. • The subject does not look at the first flash, which is an important part of Red-Eye Reduction. • The camcorder is too far from the subject. • "FLASH" is not set to "AUTO  " in the Mode Menu.	11. • The subject should look straight toward the flash, especially the first flash. If the subject does not see the first flash, it will be difficult for Red-Eye Reduction to take place (☞ pg. 26). • The flash is effective for subjects at a distance of approx. 0.7 m to 2 m from the camcorder (☞ pg. 26). • Set "FLASH" to "AUTO  " in the Mode Menu to display the Red-Eye Reduction indicator (☞ pg. 26).
12. The image taken using Snapshot is too dark.	12. • "FLASH" is set to "OFF" in the Mode Menu. • The flash emission window is covered by fingers, etc.. • The flash brightness is set to produce a darker image (adjustment value: -3). • The camcorder is too far from the subject.	12. • Set "FLASH" to any position except "OFF" in the Mode Menu (☞ pg. 26). • Do not cover the flash emission window. • Adjust the flash brightness to a larger value (☞ pg. 27). • The flash is effective for subjects at a distance of approx. 0.7 m to 2 m (☞ pg. 26).
13. The image taken using Snapshot is too bright.	13. • "FLASH" is set to "ON" in the Mode Menu.	13. • Set "FLASH" to any parameter other than "ON" in the Mode Menu (☞ pg. 26).
14. The colour of Snapshot looks strange.	14. • The light source or the subject does not include white. Or there are various different light sources behind the subject.	14. • Set "FLASH" to "ON" in the Mode Menu. Or find a white subject and compose your shot so that it also appears in the frame (☞ pg. 26).
15. Digital Zoom does not work.	15. • 10X optical zoom is selected. • The Video Echo mode is activated. • Picture Wipe or Dissolve are being used in a scene transition. • 5-Second recording was done with the Power Switch set to "5S", and with "5SD" selected in the System Menu.	15. • Turn off the Video Echo mode (☞ pg. 35). • Wait until the Picture Wipe or Dissolve effects are completed (☞ pg. 31 - 33). • Change the setting of either the System Menu or the Power Switch (☞ pg. 22).



SYMPTOM	POSSIBLE CAUSES	CORRECTIVE ACTION
16. Programme AE with special effects and Fade/Wipe Effects do not work.	16. • The Operation Switch is set to “ <b>A</b> ” and/or the Power Switch is set to “5S”.	16. • Set the Operation Switch to “ <b>M</b> ” and/or set the Power Switch to “ <b>CAMERA</b> ”.
17. The Black & White Fader does not work.	17. • The Sepia or Monotone mode is activated.	17. • Turn off Sepia and Monotone (☞ pg. 34).
18. The Dissolve function does not work.	18. • The Sepia, Monotone or Slow Shutter mode of Programme AE with special effects is activated. • The Squeeze mode is selected. • The previously selected mode of Programme AE with special effects was changed after the last selected scene for editing was registered.	18. • Turn off Sepia, Monotone or Slow Shutter before adding Dissolve to a scene transition (☞ pg. 34). • Make sure that the Squeeze mode in the Mode Menu is set to “OFF” (☞ pg. 29). • Make sure you have selected the mode of Programme AE with special effects you want before starting editing (☞ pg. 34).
19. The Picture Wipe and Dissolve functions do not work.	19. • The last selected editing scene is ending. • At the end of the last selected scene for editing, the Power Switch was set to “OFF”. • The power is off.	19. • Select Picture Wipe or Dissolve before beginning recording. The effects are then automatically activated (☞ pg. 32). • Do not turn off the camcorder’s power after setting Edit-In and Edit-Out points, as they will all be erased (☞ pg. 32). • The camcorder automatically shuts off after 5 minutes have elapsed in the Record-Standby mode. Make sure you continue operations within 5 minutes after engaging Record-Standby mode (☞ pg. 32).
20. The picture wipe function doesn’t work.	20. • The Slow Shutter mode is activated. • The Squeeze or Cinema mode is selected in the Mode Menu.	20. • Make sure the Squeeze mode, Cinema mode, or Slow Shutter mode is not activated when preparing to use the Picture Wipe function (☞ pg. 29, 35).
21. Scene transition does not go as expected.	21. • When using “Picture Wipe/ Dissolve” (☞ pg. 32) or “Dissolves during 5 second recording mode” (☞ pg. 22), there is a delay of a fraction of a second between the previous record stop-point and the Dissolve start-point. This is normal, but this slight delay becomes especially noticeable when shooting fast-moving subject or during rapid panning.	21.  <hr/>

SYMPTOM	POSSIBLE CAUSES	CORRECTIVE ACTION
22. The Video Echo mode does not work.	22. • The Picture Wipe or Dissolve functions are in use. • The Squeeze mode is selected in the Mode Menu. • A Fade-In or Fade-Out is in progress (White Fader, Black Fader or Black & White Fader). • Dissolve during 5-second mode recording is in use.	22. • Make sure the Squeeze mode is set to "OFF" (☞ pg. 28, 29). • Do not try to use the Video Echo mode during a Fade-In or Fade-Out or when Dissolve is activated during 5-second mode recording (☞ pg. 34, 35).
23. Even when Slow Shutter is not selected, the image looks like it is activated.	23. • When shooting in the dark, the unit becomes highly sensitive to light and the image takes on an effect similar to Slow Shutter.	23. • If you want the lighting to look more natural, set GAIN UP to "AGC" or "OFF" in the Mode Menu (☞ pg. 28, 29).
24. There is no strobe when the Classic Film or Strobe mode is activated.	24. • The Picture Wipe or Dissolve function is in use. • Dissolve during 5-second mode recording is in use.	24. • Do not try to use the Classic Film or Strobe mode during a scene transition (☞ pg. 34, 35).
25. White Balance cannot be activated.	25. • The Sepia or Monotone mode is activated.	25. • Turn off Sepia or Monotone before setting White Balance (☞ pg. 34, 35).
26. When shooting a subject illuminated by bright light, vertical lines appear.	26. • This is a result of exceedingly high contrast, and is not a malfunction.	26. _____
27. When the screen is under direct sunlight during shooting, the screen becomes red or black for an instant.	27. • This is not a malfunction.	27. _____
28. During recording, the date/time does not appear.	28. • "DISPLAY" is set to "OFF" in the Date/Time Menu. • Interface Shooting is performed.	28. • Set "DISPLAY" to "ON" in the Date/Time Menu (☞ pg. 20). • During Interface Shooting, the date/time does not appear (☞ pg. 17). • Set "INDICATION" to "ON" in the Date/Time Menu (☞ pg. 21).
29. The indicators and messages do not appear.	29. • "ON SCREEN" is set to "OFF" in the Date/Time Menu. • You have made the indicators disappear.	29. • Set "ON SCREEN" to "ON" in the Date/Time Menu (☞ pg. 20). • Set "INDICATION" to "ON" in the Date/Time Menu (☞ pg. 21).
30. Images on the LCD monitor appear dark or whitish.	30. • In places subject to low temperature, images become dark due to the characteristics of the LCD monitor. When this happens, the displayed colours differ from those that are actually recorded. This is not a defect of the camcorder. • When the LCD monitor's fluorescent light reaches the end of its service life, images on the LCD monitor become dark. Consult your nearest JVC dealer.	30. • Adjust the brightness and angle of the LCD monitor (☞ pg. 17).

SYMPTOM	POSSIBLE CAUSES	CORRECTIVE ACTION
31. The rear of the LCD monitor is hot.	31. • The light used to illuminate the LCD monitor causes it to become hot.	31. • Close the LCD monitor to turn it off or set the Power Switch to "OFF", and let the unit cool down.
32. The indicators and the image colour on the LCD monitor are not clear.	32. • This may occur when the surface or the edge of the LCD monitor is pressed.	32. _____
33. The LCD monitor or viewfinder indications blink.	33. • Certain Fade/Wipe effects, certain modes of Programme AE with special effects, "DIS" and other functions that cannot be used together are selected at the same time.	33. • Re-read the sections covering Fade/Wipe effects, Programme AE with special effects and "DIS" (☞ pg. 29, 31-35).
34. Coloured bright spots appear all over the LCD monitor or the viewfinder.	34. • The LCD monitor and the viewfinder are made with high-precision technology. However, black spots or bright spots of light (red, green or blue) may appear constantly on the LCD monitor or the viewfinder. These spots are not recorded on the tape. This is not due to any defect of the unit. (Effective dots: more than 99.99 %)	34. _____
35. During recording, sound cannot be heard.	35. • The optional headphones are not connected to the headphones connector. • The sound volume of the headphones connector was not adjusted appropriately. The sound volume at this point is the same as the level it was adjusted to during playback.	35. • Connect the optional headphones to the headphones connector (☞ pg. 62). • Adjust the sound volume during playback (☞ pg. 42).
36. Play, Rewind and Fast-Forward functions do not work.	36. • The Power Switch is not set to "PLAY".	36. • Set the Power Switch to "PLAY" (☞ pg. 42).
37. The tape is moving, but there is no picture.	37. • Your TV has AV input terminals, but is not set to its VIDEO mode. • The cassette's cover is open.	37. • Set the TV to the mode or channel appropriate for video playback (☞ pg. 46, 47). • Close the cassette's cover (☞ pg. 9).
38. The LCD monitor indications are distorted.	38. • During playback of the unrecorded portion, High-speed Search and still playback, LCD monitor indications appear distorted. This is not a defect.	38. _____

SYMPTOM	POSSIBLE CAUSES	CORRECTIVE ACTION
39. Images on the LCD monitor are jittery.	39. • The speaker volume is too great.	39. • Turn the speaker volume down (☞ pg. 42).
40. The LCD monitor, the viewfinder and the lens have become dirty (ex. fingerprints).	40. _____	40. • Wipe them gently with soft cloth. Wiping strongly can cause damage.
41. An unusual mark appears.	41. _____	41. • Check the section of the manual that explains LCD monitor/viewfinder indications (☞ pg. 72, 73).
42. An error indication (E01 — E06) appears.	42. • A malfunction of some kind has occurred. In this case the camcorder's functions become unusable.	42. • Remove the power supply (battery pack, etc.) and wait a few minutes for the indication to clear. When it does, you can resume using the camcorder. If the indication remains even though you repeat the above two or three times, please consult your nearest JVC dealer.
43. The charger indicator on the AC Power Adapter/Charger does not light.	43. • The temperature of the battery is extremely high/low. • Charging is difficult in places subject to extremely high/low temperatures.	43 • To protect the battery, it is recommended to charge it in places with a temperature of 10°C to 35°C (☞ pg. 76).
44. The recording mode indicator "LP" blinks.	44. • This occurs when recording in the LP mode is not available. After the indicator blinks, the recording mode switches to "SP" and recording goes on.	44. _____
45. Picture does not appear on the LCD monitor.	45. • The viewfinder is pulled out. • The LCD monitor's brightness setting is too dark.	45. • Push the viewfinder back in. • Adjust the brightness of the LCD monitor (☞ pg. 17). • If the monitor is tilted upward 180 degrees, open the monitor fully (☞ pg. 16).
46. When the image is printed from the printer, a black bar appears at the bottom of the screen.	46. • This is not a malfunction.	46. • By recording with "DIS" activated (☞ pg. 29) this can be avoided.
47. When the camcorder is connected via the DV connector, the camcorder does not operate.	47. • The DV cable was plugged/unplugged with power turned on.	47. • Turn the camcorder's power off and on again, then operate it.

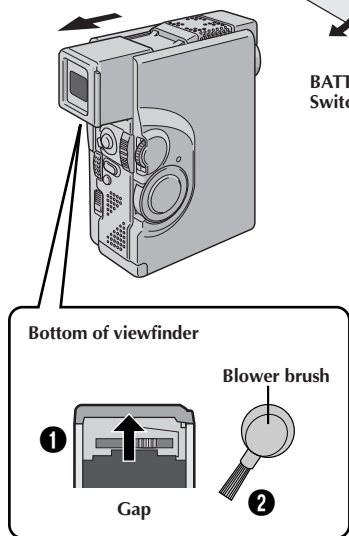
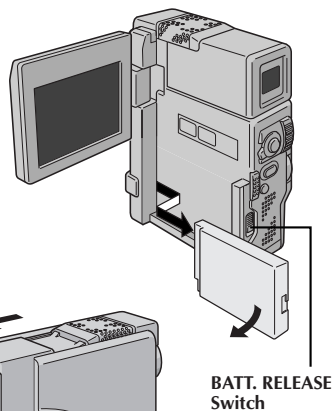
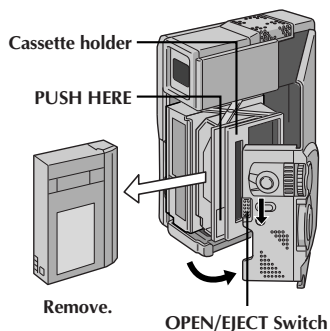

## After Use

- 1** Turn off the camcorder.
- 2** Slide down **OPEN/EJECT** in the direction of the arrow, then swing the cover open until it locks. The cassette holder opens automatically. Remove the cassette.
- 3** Press "PUSH HERE" to close the cassette cover.
- 4** Slide down **BATT. RELEASE** and remove the battery pack.

## Cleaning The Camcorder







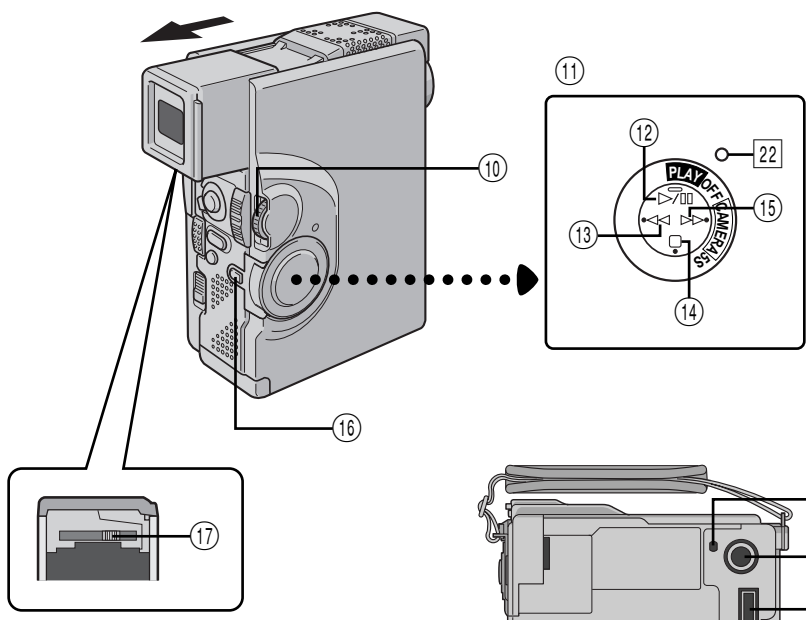
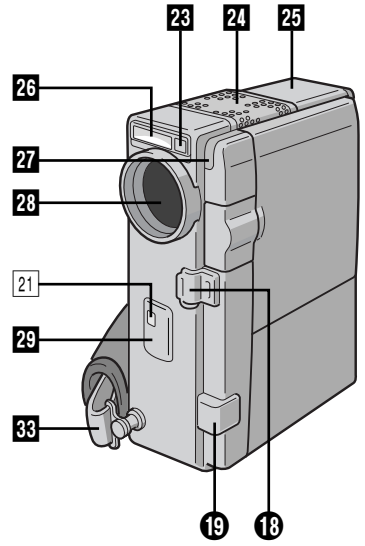
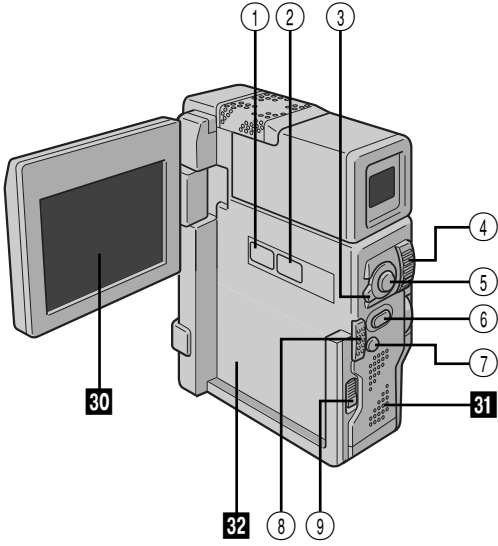











- 1 CLEAN EXTERIOR**  
Wipe gently with a soft cloth.
  - Put cloth in diluted mild soap and wring it well to wipe off heavy dirt. Then wipe again with a dry cloth.
- 2 CLEAN LCD MONITOR**  
Wipe gently with the provided cleaning cloth or a commercially available soft cloth. Be careful not to damage the monitor. Close the LCD monitor.
- 3 CLEAN LENS**  
Blow it with a blower brush, then wipe gently with lens cleaning paper.
- 4 PULL OUT VIEWFINDER FULLY**
- 5 CLEAN VIEWFINDER**  
Slide the cover in the direction of the arrow ①. Insert a lens blower or a soft cloth into the gap at the bottom of the viewfinder and clean the interior of the viewfinder with it ②.
- 6 PUSH VIEWFINDER BACK IN**  
Close the cover until it locks in place. Tilt the viewfinder horizontally, and push it back in.

## NOTES:

- Avoid using strong cleaning agents such as benzine or alcohol.
- Cleaning should be done only after the battery pack has been removed or other power units have been disconnected.
- Mould may form if the lens is left dirty.
- When using a cleaner or chemically treated cloth refer to the cautions of each product.







## Controls



- ① Snapshot Mode Button  
[SNAPSHOT MODE] .....  pg. 24
- ② Multi Screen Button  
[MULTI SCREEN] .....  pg. 25
- ③ Operation Switch [ **A** , **M** ] .....  pg. 13
- ④ • Power Zoom Lever [T/W] .....  pg. 18  
• Speaker/Headphone Volume  
Control [VOL.] .....  pg. 42
- ⑤ START/STOP Button .....  pg. 14
- ⑥ Snapshot Button [SNAPSHOT] .....  pg. 24
- ⑦ Back Light Button [BACK LIGHT] .....  pg. 38
- ⑧ OPEN/EJECT Switch .....  pg. 9
- ⑨ Battery Release Switch  
[BATT. RELEASE] .....  pg. 7
- ⑩ • MENU/SET Dial [+ , - , PUSH] .....  pg. 8, 28  
• LCD Monitor/Viewfinder Brightness  
Control .....  pg. 17
- ⑪ Power Switch .....  pg. 13
- ⑫ Play/Pause Button [▶/||] .....  pg. 42
- ⑬ Rewind Button [◀◀] .....  pg. 42
- ⑭ Stop Button [■] .....  pg. 42
- ⑮ Fast-Forward Button [▶▶] .....  pg. 42
- ⑯ Lock Button .....  pg. 13
- ⑰ Dioptre Adjustment Control .....  pg. 11

## Connectors











The connectors ⑱ to ⑳ are located beneath the cover.

- ⑱ Digital Video Connector  
[DV OUT] (i.link\*) .....  pg. 49, 51  
\* i.Link refers to the IEEE1394-1995 industry  
specification and extensions thereof. The  logo  
is used for products compliant with the i.Link  
standard.
- ⑲ • Audio/Video Output Connector  
[AV OUT] .....  pg. 46  
• Headphones Connector [ ] .....  pg. 62
- ⑳ Multi Connector  
When attached to the Docking Station, this part is  
connected.

## Indicators

- ⑲ Tally Lamp .....  pg. 14
- ⑳ Power Lamp .....  pg. 14

## Other Parts

- ㉓ Flash Sensor .....  pg. 26  
Be careful not to cover this area, as it contains a  
sensor required by the flash.
- ㉔ Stereo Microphone .....  pg. 62
- ㉕ Viewfinder .....  pg. 11
- ㉖ Flash .....  pg. 26
- ㉗ Camera Sensor  
Be careful not to cover this area; a sensor  
necessary for shooting is built-in here.
- ㉘ Lens Cover  
Opens when the viewfinder is pulled out or the  
LCD monitor is opened fully.
- ㉙ Remote Sensor .....  pg. 52
- ㉚ LCD Monitor .....  pg. 17
- ㉛ Speaker .....  pg. 42
- ㉜ Battery Pack Mount .....  pg. 7
- ㉝ Grip Strap .....  pg. 11
- ㉞ Stud Hole .....  pg. 46
- ㉟ Tripod Mounting Socket .....  pg. 12, 46

## LCD Monitor/Viewfinder Indications During Recording

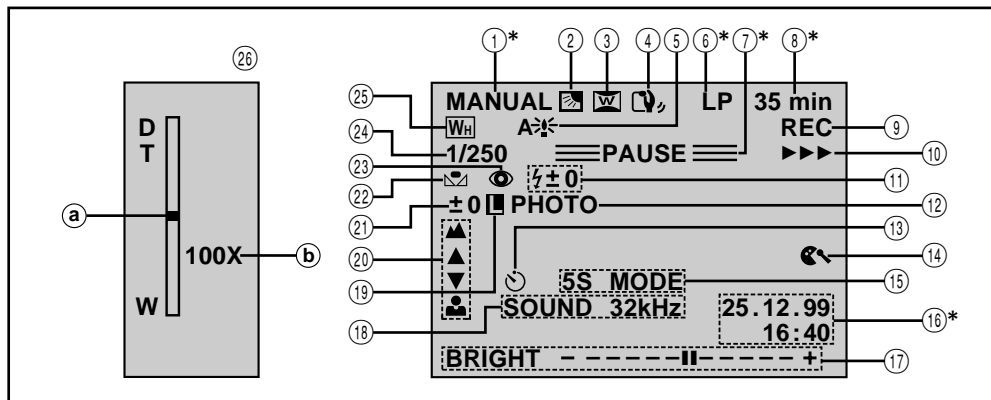

No.	Function	
①*	Displays the operation mode position.	(☞ pg. 13)
②	Appears when backlight compensation is used.	(☞ pg. 38)
③	Appears when in the Squeeze or Cinema mode.	(☞ pg. 29)
④	Appears when Digital Image Stabiliser ("DIS") is engaged.	(☞ pg. 29)
⑤	Appears when Auto Slow Shutter is engaged ("GAIN UP" is set to "AUTO").	(☞ pg. 29)
⑥*	Displays the recording mode (SP or LP).	(☞ pg. 10)
⑦*	Appears when in the Record-Standby mode.	(☞ pg. 14)
⑧*	Displays the tape remaining time.	(☞ pg. 15)
⑨	Appears during recording.	(☞ pg. 14)
⑩	Appears while the tape is running.	(☞ pg. 14)
⑪	Appears when the flash is ready. A number appears next to the indication after adjusting the brightness of the flash.	(☞ pg. 26, 27)
⑫	Appears when taking a Snapshot.	(☞ pg. 24)
⑬	Appears during Self-Timer recording.	(☞ pg. 23)
⑭	Appears when the wind cut mode is engaged to cut down on noise created by wind.	(☞ pg. 30)
⑮	5S MODE/5SD MODE/ANIM. MODE: Displays the 5 second recording mode, Dissolve during 5 second recording mode or Animation recording mode.	(☞ pg. 22, 30)
⑯*	Displays the date/time.	(☞ pg. 20)
⑰	Displays the brightness of the LCD monitor or the viewfinder.	(☞ pg. 17)
⑱	Displays the sound mode for approx. 5 seconds after turning on the camcorder.	(☞ pg. 30)
⑲	Appears when the iris is locked.	(☞ pg. 39)
⑳	Appears when the focus is adjusted manually.	(☞ pg. 37)
㉑	Appears when the exposure is adjusted.	(☞ pg. 38)
㉒	Appears when the white balance is adjusted.	(☞ pg. 41)
㉓	Appears when "FLASH" is set to "AUTO" (☞) in the Mode Menu.	(☞ pg. 26)
㉔	Displays the selected Programme AE with special effects.	(☞ pg. 34)
㉕	Displays the selected Fade/Wipe effect.	(☞ pg. 31)
㉖	Appears during zooming. ㉖ a Zoom level indicator ㉖ b Approximate zoom ratio	(☞ pg. 18)

\* : Setting "INDICATION" to "OFF" in the Date/Time Menu lets you remove indications marked with \* from the screen (☞ pg. 21).



## LCD Monitor/Viewfinder Indications During Playback

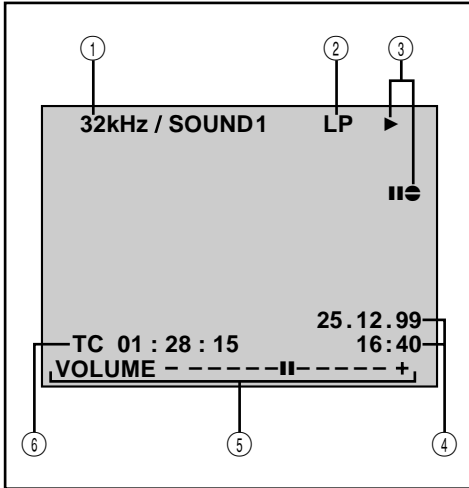

No.	Function
①	Displays the sound mode. (☞ pg. 45)
②	Displays the tape speed.
③	Appears while a tape is running. ▶▶ : Playback ▶▶▶ : Fast-Forward/Shuttle search ◀◀ : Rewind/Shuttle search    : Pause ▶▶▶ : Forward slow-motion ◀◀◀ : Reverse slow-motion ◐ : Audio Dubbing ◐◐ : Audio Dubbing Pause
④	Displays the date/time. (☞ pg. 45)
⑤	BRIGHT: Displays the brightness of the LCD monitor or the viewfinder. (☞ pg. 17) VOLUME: Displays the speaker or headphone volume. (☞ pg. 42)
⑥	Displays the time code. (☞ pg. 45)

## Warning Indications

Indications	Function
	Displays the battery remaining power. Remaining power level: high Remaining power level: exhausted As the battery power comes close to nil, the battery indicator  blinks. When the battery power is exhausted, power turns off automatically.
	Appears when no tape is loaded, or when the erase protection tab is set to "SAVE". (☞ pg. 9)
	Appears if dirt is detected on the heads during recording. (☞ pg. 77)
	Appears if condensation occurs. When this indication is displayed, the camcorder turns off automatically.
TAPE!	Appears for 10 seconds after power is turned on if there is no tape loaded.
TAPE END	Appears when the tape ends during recording or playback. (☞ pg. 15)
SET DATE/TIME!	<ul style="list-style-type: none"> <li>Appears when the date/time is not set. (☞ pg. 8)</li> <li>Appears when the clock (lithium) battery is discharged and the previously set date/time is erased. (☞ pg. 8)</li> </ul>
ERROR! REFER MANUAL	Appears when Audio Dubbing is unavailable. (☞ pg. 62)
E01 — E06	The error indications (E01 — E06) show what type of malfunction has occurred. When an error indication appears, the camcorder turns off automatically. Remove the power supply (battery, etc.) and wait a few minutes for the indication to clear. When it does, you can resume using the camcorder. If the indication remains, consult your nearest JVC dealer. (☞ pg. 68)

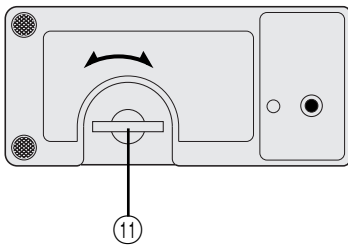
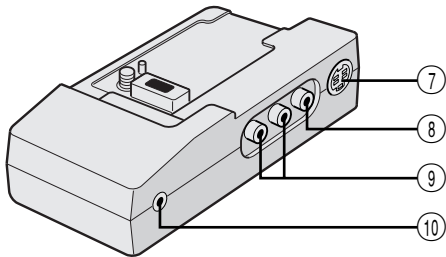
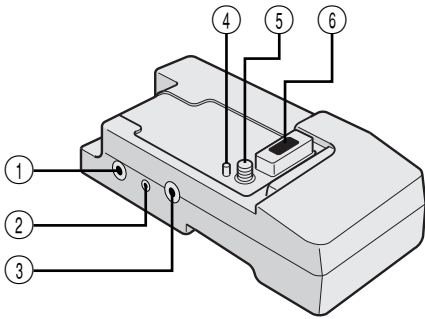

- ① JLIP (Joint Level Interface Protocol) Connector  
Connect to a JLIP-compatible camcorder or VCR to control it from the computer using the provided Software.

**NOTE:**





Make sure that the camcorder is turned on while connecting the camcorder to a PC using the Docking Station's JLIP connector. If the camcorder is turned off (because the Power Switch is set to "OFF" or due to Auto Shut Off\* etc.) while the JLIP programme software is used, it will be impossible to control the connected devices from the computer. In such a case, first try turning the camcorder on again, or unplug the JLIP connection cable from the Docking Station's JLIP connector. Then, initialize or run the software again.

**\* Auto Shut Off:**







If 5 minutes elapse in the Record-Standby mode or in the Pause mode, the camcorder's power shuts off automatically to conserve energy.

- ② PC Connector [DIGITAL STILL] ..... ☞ pg. 48
- ③ Edit Connector [EDIT] ..... ☞ pg. 57  
Connect the editing cable when performing Random Assemble Editing (☞ pg. 56 – 61).
- ④ Stud ..... ☞ pg. 46
- ⑤ Screw ..... ☞ pg. 46
- ⑥ Multi Connector  
The Docking Station can be connected with this camcorder through this connector. Never touch it with your hand or hit it with a hard object; if the pins are damaged, the connectors will become unusable due to contact failure.
- ⑦ S-Video Output Connector  
[S OUT] ..... ☞ pg. 46, 57
- ⑧ Video Output Connector  
[VIDEO] ..... ☞ pg. 46, 57
- ⑨ Audio Output Connector  
[AUDIO L/R] ..... ☞ pg. 46, 57
- ⑩ External Stereo Microphone Input  
Connector [MIC] ..... ☞ pg. 62
- ⑪ Screw Knob ..... ☞ pg. 46  
To attach the camcorder, tighten this clockwise.





## A

- AC Power Adapter/Charger .....  pg. 6, 7
- Animation .....  pg. 30
- Audio Dubbing .....  pg. 62
- Auto Focus .....  pg. 36
- Auto Shut off .....  pg. 15, 42











## B

- Back Light Compensation .....  pg. 38
- Battery Low .....  pg. 73
- Battery Pack .....  pg. 6, 7, 76
- Beep/Tally .....  pg. 30
- Brighten The LCD Monitor .....  pg. 17
- Built-in Clock's Lithium Battery .....  pg. 8



## C

- Charge The Battery Pack .....  pg. 6
- Cinema .....  pg. 29
- Classic Film .....  pg. 35
- Clean The Camcorder .....  pg. 69
- Connections .....  pg. 7, 46 – 51, 57





## D

- Darken The LCD Monitor .....  pg. 17
- Date/Time Display .....  pg. 20, 45
- Date/Time Settings .....  pg. 8
- Demonstration Mode .....  pg. 30
- Digital Dubbing .....  pg. 51
- Digital Zoom .....  pg. 18, 29
- DIS (Digital Image Stabiliser) .....  pg. 29
- Dioptré Adjustment .....  pg. 11
- Dissolve During 5-second Recording Mode .....  pg. 22
- Dubbing .....  pg. 50



## E

- Erase Protection .....  pg. 9
- Exposure Control .....  pg. 38



## F

- Fade-In/Out .....  pg. 31
- Fast-Forward The Tape .....  pg. 42
- 5-second recording mode .....  pg. 22
- Flash .....  pg. 26

## G

- Gain Up .....  pg. 29
- Grip Adjustment .....  pg. 11

## I

- Interface Shooting .....  pg. 17
- Iris .....  pg. 39
- Iris Lock .....  pg. 39

## J

- Journalistic Shooting .....  pg. 17

## L

- LCD monitor/Viewfinder Indications ...  pg. 72, 73
- Load A Tape .....  pg. 9

## M







- Manual Focus .....  pg. 37

- Mode Menu .....  pg. 29
- Monotone .....  pg. 35
- Motor Drive Mode .....  pg. 24
- Multi Screen Mode .....  pg. 25









## O

- Operation Switch Position .....  pg. 13















## P

- Picture Wipe/Dissolve .....  pg. 32
- Playback Menu .....  pg. 44
- Playback Special Effects .....  pg. 55
- Playback Zoom .....  pg. 54
- Power Switch Position .....  pg. 13
- Programme AE With Special Effects .....  pg. 34
- Provided Accessories .....  pg. 3





## R

- Random Assemble Editing .....  pg. 56 – 61
- Record-Standby .....  pg. 14
- Recording Format .....  pg. 4
- Recording Menu .....  pg. 29
- Recording Mode .....  pg. 10
- Red-Eye Reduction .....  pg. 26
- Remote Control .....  pg. 52
- Rewind The Tape .....  pg. 42

## S

- Self-Recording .....  pg. 17
- Self-Timer .....  pg. 23
- Sepia .....  pg. 35
- Set Remote Control/VCR Code .....  pg. 56
- Shuttle Search .....  pg. 43
- Shutter Speed .....  pg. 35
- Slow-Motion Playback .....  pg. 54
- Slow Shutter .....  pg. 35
- Snapshot Mode .....  pg. 24
- Sound Mode .....  pg. 30, 45
- Specifications .....  pg. 78, 79
- Squeeze .....  pg. 29
- Still Playback .....  pg. 43
- Strobe .....  pg. 35
- System Menu .....  pg. 30

## T

- Tele Macro .....  pg. 30
- Time Code .....  pg. 4, 19
- Tripod Mounting .....  pg. 12
- Twilight .....  pg. 35





## U

- Unload A Tape .....  pg. 9

## V

- Video Echo .....  pg. 35

## W

- White Balance .....  pg. 40, 41
- Wide Mode .....  pg. 29
- Wind Cut .....  pg. 30
- Wipe In/Out .....  pg. 31

## Z

- Zooming .....  pg. 18

## Battery Packs

The supplied battery pack is a lithium-ion battery. Before using the supplied battery pack or an optional battery pack, be sure to read the following cautions:

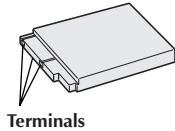

Terminals

### 1. To avoid hazard . . .

- .... do not burn.
- .... do not short-circuit the terminals.
- .... do not modify or disassemble.
- .... do not expose the battery to temperatures exceeding 60°C (140°F), as this may cause the battery to overheat, explode or catch fire.
- .... use only specified chargers.

### 2. To prevent damage and prolong service life . . .

- .... do not subject to unnecessary shock.
- .... charge in an environment where temperatures are within the tolerances shown in the chart below. This is a chemical reaction type battery—cooler temperatures impede chemical reaction, while warmer temperatures can prevent complete charging.
- .... store in a cool, dry place. Extended exposure to high temperatures will increase natural discharge and shorten service life.
- .... fully charge and then fully discharge the battery every 6 months when storing the battery pack over a long period time.
- .... remove from charger or powered unit when not in use, as some machines use current even when switched off.

## NOTES:

- *It is normal for the battery pack to be warm after charging, or after use.*

### Temperature Range Specifications

Charging .....	10°C to 35°C (50°F to 95°F)
Operation .....	0°C to 40°C (32°F to 104°F)
Storage .....	-10°C to 30°C (-14°F to 86°F)

- *Recharging time is based on room temperature of 20°C (68°F).*
- *The lower the temperature, the longer recharging takes.*

## Cassettes

To properly use and store your cassettes, be sure to read the following cautions:

### 1. During use . . .

- .... make sure the cassette bears the Mini DV mark.
- .... be aware that recording onto prerecorded tapes automatically erases the previously recorded video and audio signals.
- .... make sure the cassette is positioned properly when inserting.

- .... do not load and unload the cassette repeatedly without allowing the tape to run at all. This slackens the tape and can result in damage.
- .... do not open the front tape cover. This exposes the tape to fingerprints and dust.

### 2. Store cassettes . . .

- .... away from heaters or other heat sources.
- .... out of direct sunlight.
- .... where they won't be subject to unnecessary shock or vibration.
- .... where they won't be exposed to strong magnetic fields (such as those generated by motors, transformers or magnets).
- .... vertically, in their original cases.

## LCD Monitor

### 1. To prevent damage to the LCD monitor, DO NOT . . .

- .... push it strongly or apply any shocks.
- .... place the camcorder with the LCD monitor on the bottom.

### 2. To prolong service life . . .

- .... avoid rubbing it with coarse cloth.

### 3. Be aware of the following phenomena for LCD monitor use.

#### These are not malfunctions:

- While using the camcorder, the surface around the LCD monitor and/or the back of the LCD monitor may heat up.
- If you leave power on for a long time, the surface around the LCD monitor becomes hot.

## Main Unit

### 1. For safety, DO NOT . . .

- .... open the camcorder's chassis.
- .... disassemble or modify the unit.
- .... short-circuit the terminals of the battery pack. Keep it away from metallic objects when not in use.
- .... allow inflammables, water or metallic objects to enter the unit.
- .... remove the battery pack or disconnect the power supply while the power is on.
- .... leave the battery pack attached when the camcorder is not in use.

### 2. Avoid using the unit . . .

- .... in places subject to excessive humidity or dust.
- .... in places subject to soot or steam such as near a cooking stove.
- .... in places subject to excessive shock or vibration.
- .... near a television set.
- .... near appliances generating strong magnetic or electric fields (speakers, broadcasting antennas, etc.).

.... in places subject to extremely high (over 40°C or 104°F) or extremely low (under 0°C or 32°F) temperatures.

### 3. DO NOT leave the unit . . .

.... in places of over 50°C (122°F).  
 .... in places where humidity is extremely low (below 35%) or extremely high (above 80%).  
 .... in direct sunlight.  
 .... in a closed car in summer.  
 .... near a heater.

### 4. To protect the unit, DO NOT . . .

.... allow it to become wet.  
 .... drop the unit or strike it against hard objects.  
 .... subject it to shock or excessive vibration during transportation.  
 .... keep the lens directed at extremely bright objects for long periods.  
 .... expose the lens to direct sunlight.  
 .... carry it by holding the LCD monitor or the viewfinder.  
 .... swing it excessively when using the hand strap or the grip.  
 .... swing the soft camera case excessively when the camcorder is inside it.

### 5. Dirty heads can cause the following problems:



- No picture during playback.
- Blocks of noise appear during playback.
- During recording, the Head Clog Warning indicator "⊗" appears.

In such cases, use the optional Cleaning Cassette. Insert it and play back. If the cassette is used more than once consecutively, damage to the video heads may result. After the camcorder plays back for about 20 seconds, it stops automatically. Also refer to the Cleaning Cassette's instructions.

If, after using the Cleaning Cassette, the problems still exist, consult your nearest JVC dealer.

Mechanical moving parts used to move the video heads and video tape tend to become dirty and worn out over time. In order to maintain a clear picture at all times, periodic check-ups are recommended after using the unit for about 1,000 hours. For periodic check-ups please consult your nearest JVC dealer.

## How To Handle A CD-ROM

- Take care not to soil or scratch the mirror surface (opposite to the printed surface). Do not write anything or put a sticker on either the front or back surface. If the CD-ROM gets dirty, gently wipe it with a soft cloth outward from the centre hole using a circular motion.
- Do not use conventional disc cleaners or cleaning spray.
- Do not bend the CD-ROM or touch its mirror surface.
- Do not store your CD-ROM in a dusty, hot or humid environment. Keep it away from direct sunlight.

### About moisture condensation . . .

- You have observed that pouring a cold liquid into a glass will cause drops of water to form on the glass' outer surface. This same phenomenon occurs on the head drum of a camcorder when it is moved from a cool place to a warm place, after heating a cold room, under extremely humid conditions or in a place directly subjected to the cool air from an air conditioner.
- Moisture on the head drum can cause severe damage to the video tape, and can lead to internal damage to the camcorder itself.



### Serious malfunctioning

If malfunctioning occurs, stop using the unit immediately and consult your local JVC dealer.

The camcorder is a microcomputer-controlled device. External noise and interference (from a TV, a radio, etc.) might prevent it from functioning properly. In such cases, first disconnect its power supply unit (battery pack, AC Power Adapter/Battery Charger, etc.) and wait a few minutes and then re-connect it and proceed as usual from the beginning.

**Camcorder****General**

---



<b>Power supply</b>	: DC 6.3 V  (Using the AC Power Adapter/Charger) DC 7.2 V  (Using battery pack)
<b>Power consumption</b>	
<b>LCD monitor off, viewfinder on</b>	: Approx. 4.5 W
<b>LCD monitor on, viewfinder off</b>	: Approx. 5.4 W
<b>Format</b>	: DV Format (SD mode)
<b>Signal format</b>	: PAL Standard
<b>Video signal recording format</b>	: Digital Component Recording
<b>Cassette</b>	: Mini DV Cassette
<b>Tape Speed</b>	: SP: 18.8 mm/s LP: 12.5 mm/s
<b>Maximum recording time</b>	: SP: 60 min. LP: 90 min. (using M-DV60ME cassette)
<b>Pickup</b>	: 1/4" CCD
<b>Lens</b>	: F 1.8, f = 3.6 to 36 mm, 10:1 Power Zoom Lens
<b>Filter diameter</b>	: ø27 mm
<b>LCD monitor</b>	: 2.5" diagonally measured, LCD panel/TFT active matrix system
<b>Viewfinder</b>	: Electronic viewfinder with 0.55" colour LCD
<b>Speaker</b>	: Monaural
<b>Operating temperature</b>	: 0°C to 40°C
<b>Operating humidity</b>	: 35% to 80%
<b>Storage temperature</b>	: -20°C to 50°C
<b>Dimensions</b>	: 48 (W) x 119 (H) x 89 (D) mm (with the LCD monitor closed and the viewfinder pushed back in)
<b>Weight</b>	: Approx. 420 g (without grip strap, cassette and battery) Approx. 505 g (incl. grip strap, cassette and battery)

**Connectors**

---

<b>Video output</b>	: 1 V <sub>p-p</sub> , 75 Ω unbalanced, analogue output (via AV OUT connector)
<b>Audio output</b>	: -8 dBs, 1 kΩ analogue output, stereo (via AV OUT connector)
<b>Headphone output</b>	: ø3.5 mm, stereo (via AV OUT connector)
<b>DV output</b>	: 4-pin, IEEE1394 compliant

**AC Power Adapter/Charger AA-V50EK**

<b>Power requirement</b>	: AC 110 V to 240 V <sub>~</sub> , 50/60 Hz
<b>Power consumption</b>	: 20 W
<b>Output</b>	
<b>Charge</b>	: DC 7.2 V  , 0.63 A
<b>VTR</b>	: DC 6.3 V  , 1.8 A
<b>Dimensions</b>	: 122 (W) x 39 (H) x 92 (D) mm
<b>Weight</b>	: Approx. 380 g

*Specifications shown are for SP mode unless otherwise indicated. E & O.E. Design and specifications subject to change without notice.*

## Docking Station

### General

---

Dimensions	: 115 mm (W) x 31 mm (H) x 55 mm (D)
Weight	: Approx. 90 g

### Connectors

---

S-Video	: Y: 1 Vp-p, 75 $\Omega$ , analogue output C: 0.29 Vp-p, 75 $\Omega$ , analogue output
Video	: 1 Vp-p, 75 $\Omega$ , analogue output
Audio	: -8 dBs, 1 k $\Omega$ , analogue output
JLIP	: $\varnothing$ 3.5 mm, 4-pole, mini-head jack (compatible with RC-5325 plug)
Editing	: $\varnothing$ 3.5 mm diameter, 2-pole
PC	: $\varnothing$ 2.5 mm, 3-pole
External microphone input	: -68 dBs, high impedance unbalanced with $\varnothing$ 3.5 mm (stereo)

*E & O.E. Design and specifications subject to change without notice.*

